



# Wastewater Treatment Solutions



WASTEWATER TREATMENT SYSTEMS  
SEPTIC TANKS CESSPOOLS INFILTRATION



Headquarters at Teningen near Freiburg



## GRAF – solutions for global challenges

*Pure, clean water is one of our most important resources. GRAF develops, manufactures and markets an extensive range of products for water management. GRAF provides solutions to global challenges, such as protecting watercourses or preventing flooding, with typical German quality.*

### Active in over 70 countries, with roots in Germany

GRAF products are exported to more than 70 countries around the world. Despite being highly active abroad, GRAF is also continually investing in its headquarters at Teningen. By constructing its raw materials competence centre in Herbolzheim, GRAF is expanding its German roots yet further.

### Sustainably manufactured environmental products

GRAF environmental products are 100% recyclable and are designed for as long a life as possible. This ensures that fewer resources are used and the environmental impact is minimised. Right from the stage of developing its products, GRAF attaches great importance to sustainable product design. Through years of intensive research, GRAF has managed to replace 70% of the raw materials used in production with recycled products – without compromising product quality. This also improves the environmental performance of the GRAF product range. Sustainability is also hugely important during the manufacturing process. For example, the waste heat from production is used to heat the production and logistics building.

### From pioneer to market leader

GRAF has over 50 years of experience in the development and manufacturing of high-quality plastic products. The company launched its first rainwater barrels in 1974 with the slogan „Rainwater is free“ and soon started marketing other rainwater harvesting products too. GRAF’s innovative and user-friendly water management solutions have since made the company a leading system vendor in Europe.

### Quality comes first

GRAF uses state-of-the-art production facilities. A high standard of quality in production is an essential starting point for unique products. End-to-end quality assurance and a high level of automation guarantee maximum reliability in production. Because of our high standard of quality, we offer a warranty of up to 15 years on GRAF products.

### GRAF and KLARO – two strong wastewater technology brands

Just as the GRAF wastewater tank is a state-of-the-art product, for over 10 years the KLARO brand has been synonymous with reliable wastewater treatment technology. KLARO, the European market leader in SBR wastewater treatment systems with pneumatic lifting technology, has been a member of the GRAF group since 2014. Every GRAF wastewater product therefore benefits from the experience gained from over half a million satisfied wastewater customers and the quality of two established brands in decentralised wastewater treatment.



Manufacturing certified according to ISO 9001



Manufacturing certified according to ISO 5001

### Plastic – clear advantages over concrete

Concrete tanks are at risk of corrosion through constant contact with wastewater and may require expensive refurbishment. Plastic tanks, on the other hand, have smooth inner surfaces that will not corrode. Also, because of their low weight, plastic tanks can be installed without heavy equipment. This means that they can be easily transported and installed in locations that are difficult to access.

### Fast responses, even when special solutions are needed

GRAF products are exported around the globe. Intelligent logistics and sufficient stock levels ensure first-class availability of standard solutions, as well as for customised wastewater solutions.



Teningen warehouse

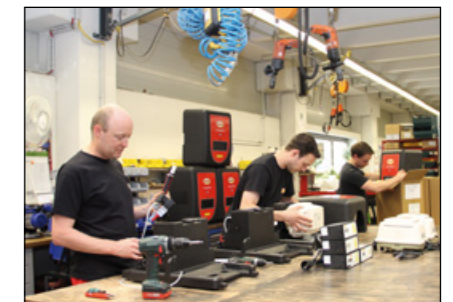

Final assembly of switch cabinets



Final assembly of conversion kits

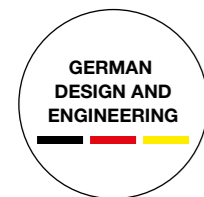

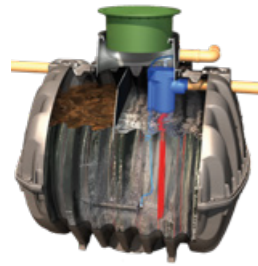

## SMALL BIOLOGICAL WASTEWATER TREATMENT SYSTEMS

one2clean/one2clean plus – Facts		10
one2clean/one2clean plus: One-tank system	3–9 PE	12
Two-tank system	7–18 PE	
one2clean / one2clean plus – Benefits		14
Klaro E Professional – Facts		16
Klaro E Professional – Multitank system	16–50 PE	18
Klaro E Professional – Benefits		20
Klaro E Professional for retrofitting	5–50 PE	22
Accessories		24



## CARAT UNDERGROUND TANK

Carat RS underground tank – the GRAF modular system	74
Carat RS underground tank – benefits	76
Carat RS underground tank – tank sizes	79
Carat RS underground tank – tank domes and covers	80
Carat RS underground tank – baffle positions	82
Carat RS underground tank – system packs	83
Carat XL underground tank	84
Carat XXL underground tank	85



## INFILTRATION

Infiltration Tunnel	88
---------------------	----



## LARGE BIOLOGICAL WASTEWATER TREATMENT SYSTEMS

one2clean plus XXL	24–70 PE	36
Klaro L	60–180 PE	38
Klaro XL	38–200 PE	40
Klaro XXL	75–1000 PE	42
Klaro XXL Retrofitting	100–1500 PE	44
External Cabinets		46

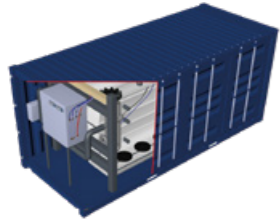

## CONTAINER.BLUE

50



## POWERLESS WASTEWATER TREATMENT SYSTEMS

Biomatic system		56
Anaerobix – Wastewater Treatment System with Biological Filter		58
Anaerobix XL/XXL		60
Carat RS Septic tank		62
Cesspools		63
Herkules Septic Tank and Cesspool		65



## SEPARATORS

Grease separator		68
Light fluid separator		70

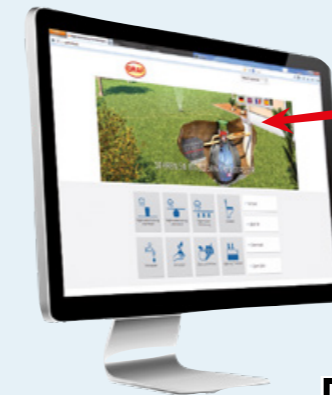

**Webcode G5101**

**The webcode takes you straight to the information you need.**

- Installation instructions
- Dimensional drawings
- Accreditations
- Declarations of conformity



[www.graf.info](http://www.graf.info)

## Symbols used in this catalogue

### Load capacity

- Suitable for pedestrian loading
- Suitable for vehicle loading
- Suitable for lorry loading

Dimension your system comfortable with our online product advisor!

- GRAF Cesspool advisor
- GRAF Wastewater advisor

[www.graf.info](http://www.graf.info)



# Small Biological Wastewater Treatment System

- › one2clean / one2clean plus Page 10
- › Klaro E Professional Page 16
- › Klaro E Professional for retrofitting Page 22
- › Accessories Page 24

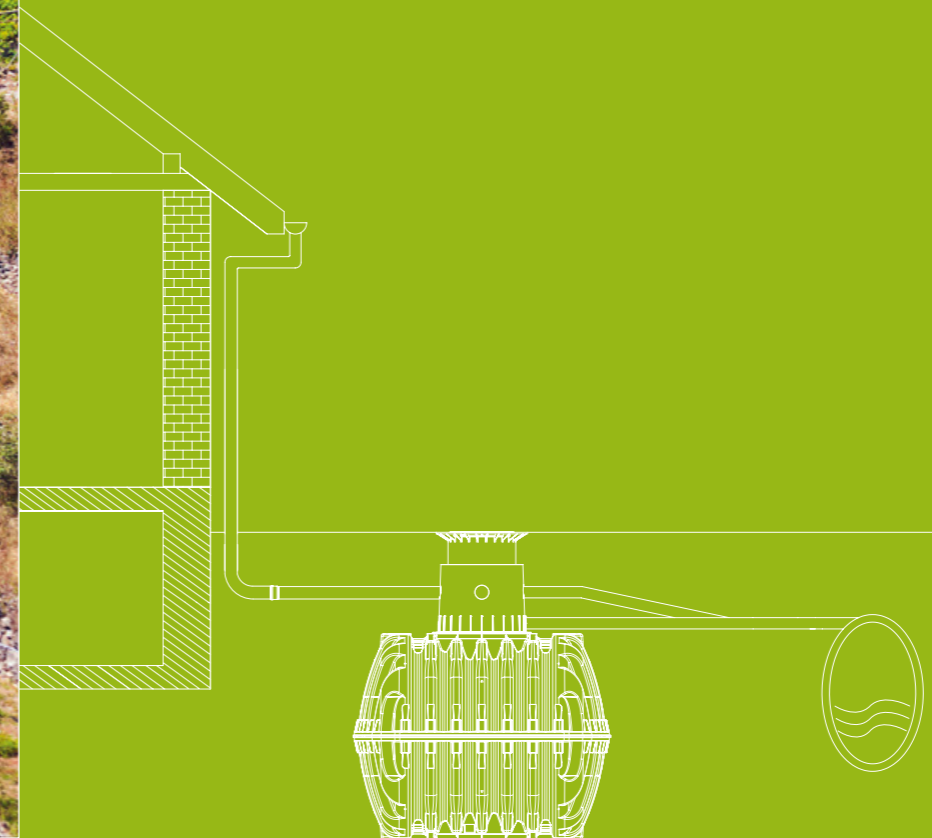

## System comparison



System	one2clean	one2clean plus	Klaro E Professional KL24base	Klaro E Professional KL24plus
Page	10	10	16	16
System conformity	EN 12566-3	EN 12566-3	EN 12566-3	EN 12566-3
Purifying technology	fully biological SBR lifting technology	fully biological SBR lifting technology	fully biological SBR lifting technology	fully biological SBR lifting technology
One-tank systems available up to	9 inhabitants   1,350 l/d	9 inhabitants   1,350 l/d	on request	on request
Multitank systems available up to	18 inhabitants   2,700 l/d	18 inhabitants   2,700 l/d	50 inhabitants   7,500 l/d	50 inhabitants   7,500 l/d
Maintenance interval	1–2 per year	1–2 per year	1–2 per year	1–2 per year
Warranty for underground tank	15 years	15 years	15 years	15 years
Warranty for purifying technology	3 years	3 years	3 years	3 years
<b>Control</b>				
+K Holiday / economy mode (underload detection)	—	●	—	●
+R Remote transmission controlled by GSM (CSD, GPRS as option) or LAN	—	○	—	○
+P Phosphate removal	—	○	—	○
+C Carbon infeed	—	○	—	○
+H Hygiene package (Disinfection)	—	○	—	○
+D Removal of nitrogen	●	●	○	○
+B Buffer pump for short-term peak loads	—	—	—	○
+O Outlet with clear water pump	—	○	—	○
Control power failure recognition	—	●	●	●
Temperature sensor to protect against overheating	—	●	—	●
Logbook function	●	●	●	●
Operation	4 keys	14 keys	4 keys	14 keys
Serial interface for software updates	—	●	●	●
External control cabinet for installing control unit outdoors	○	○	○	○
Annual power consumption	188 kWh (5 inhabitants   750 l/d)	358 kWh (5 inhabitants   750 l/d)	349 kWh (8 inhabitants   1,200 l/h)	349 kWh (8 inhabitants   1,200 l/h)

● Standard equipment ○ Available as options — not available

Parameter	Cleaning performance for one2clean	Cleaning performance for one2clean plus	Cleaning performance for Klaro E Professional KL24base		Cleaning performance for Klaro E Professional KL24plus	
COD (chemical oxygen demand)	94.2 %	94.7 %	91.9 %	51 mg/l	93.1 %	47 mg/l
BOD <sub>5</sub> (biochemical oxygen demand)	98.0 %	98.1 %	95.9 %	12 mg/l	96.9 %	10 mg/l
SS (suspended solids)	96.3 %	95.7 %	94.4 %	20 mg/l	96.9 %	11 mg/l
NH <sub>4</sub> -N	98.3 %	88.7 %	65.6 %	12 mg/l	74.7 %	11 mg/l
N <sub>total</sub>	87.0 %	86.8 %	57.1 %	24 mg/l	69.9 %	21 mg/l
P <sub>total</sub>	—	95.1 %	—	—	94.5 %	0.4 mg/l
eColi	—	99.9 %	—	—	99.9 %	—

Results of practical testing undertaken by the Prüfinstitut für Abwassertechnik (Testing Institute for Wastewater Technology), Aachen

# one2clean / one2clean plus – Facts

3–18 PE (450–2,700l/day)



## Why use the one2clean system?

**As much technology as necessary, as little technology as possible.**

Over the past few years, wastewater treatment systems have experienced impressive technological developments. Today, they are high-tech products equipped with sophisticated controls and various pumps, sensors and valves. Yet this is often to the detriment of the product's reliability. A reliable wastewater disposal system no longer needs to be complicated. one2clean is an advanced development of the proven SBR wastewater treatment technology, with considerable advantages in terms of operating costs and safety.

- **Excellent cleaning performance**  
Even during load fluctuations and underload
- **Great value for money**
- **Double sludge storage volume**
- **Low sludge removal**

# one2clean is a clean solution

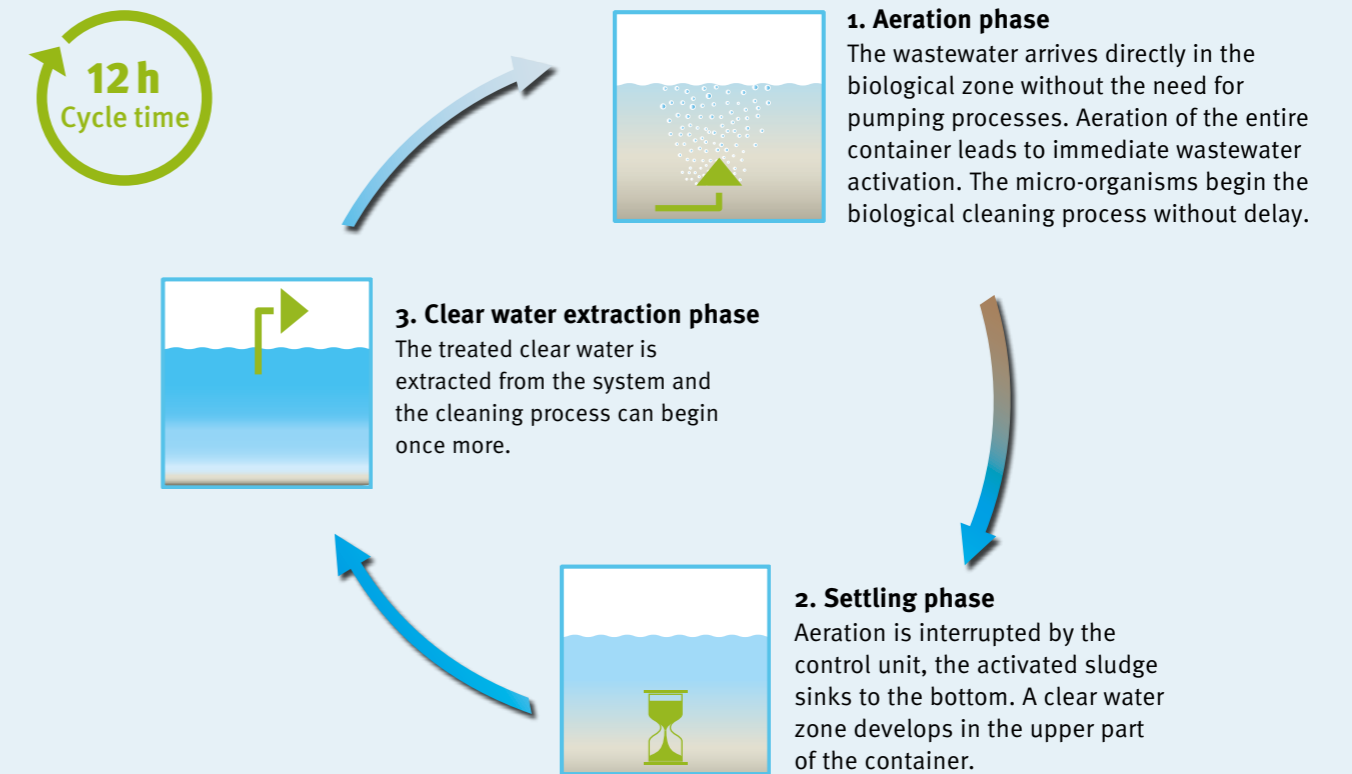

**one2clean only needs 3 steps to produce clear water**  
The wastewater treatment is carried out in one chamber in just one tank. This eliminates unnecessary pumping processes and sludge return.

**one2clean is odourless**  
The entire volume of wastewater is immediately activated with oxygen using the unique one2clean technology. The final process of the one2clean produces an odourless, clear treated water for extraction to soakaway or waterway \*

**one2clean already meets the needs of tomorrow**  
The one2clean wastewater treatment system can achieve sustainable discharge values with an efficiency factor of up to 99%! This offers high investment security – even if legal requirements become stricter.

## ✓ Minimal power consumption



**Only 38 kWh per person and per year!**

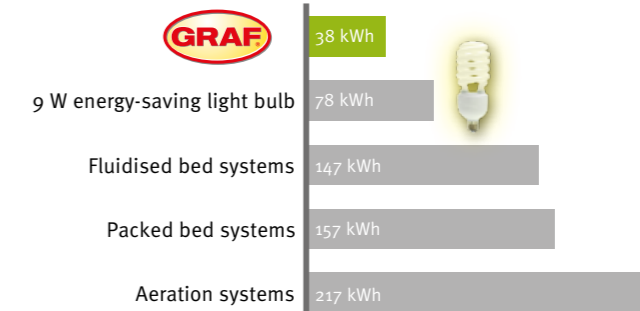

\* Manufacturer's operating and installation instructions must be adhered to.

# one2clean / one2clean plus

One-tank and two-tank systems



**3**  
years  
warranty  
on technology

**15**  
years  
warranty  
on wastewater tanks



## Technical data

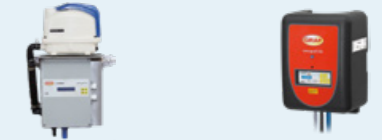

System	one2clean	one2clean plus
System conformity	EN 12566-3	EN 12566-3
Purifying technology	fully biological SBR lifting technology	fully biological SBR lifting technology
One-tank systems available up to	9 inhabitants   1,350 l/d	9 inhabitants   1,350 l/d
Two-tank systems available up to	18 inhabitants   2,700 l/d	18 inhabitants   2,700 l/d
Maintenance interval	1–2 per year	1–2 per year
Warranty for underground tank	15 years	15 years
Warranty for purifying technology	3 years	3 years

Parameter	one2clean	one2clean plus
COD (chemical oxygen demand)	94.2% 43 mg/l	94.7% 36 mg/l
BOD <sub>5</sub> (biochemical oxygen demand)	98.0% 7 mg/l	98.1% 6 mg/l
SS (suspended solids)	96.3% 14 mg/l	95.7% 14 mg/l
NH <sub>4</sub> -N	98.3% 0.5 mg/l	88.7% 4.6 mg/l
N <sub>total</sub>	87.0% 7.9 mg/l	86.8% 9.1 mg/l
P <sub>total</sub>	–	95.1% 1.6 mg/l
eColi	–	99.9% –

Results of practical testing undertaken by the Prüfinstitut für Abwassertechnik (Testing Institute for Wastewater Technology), Aachen

Ideal for infiltration of cleaned wastewater



>> page 88

## Accessories:

>> page 24

### One-tank system one2clean / one2clean plus

Q Webcode G5104 Q Webcode G5113

Inhabitants [max.]	Max. daily flow [l/d]	Max. organic load [kg BOD <sub>5</sub> /d]	Total volume [l]	Volume [l]	Length* [mm]	Width* [mm]	Height [mm]	Weight [kg]
1–3	450	0.18	2,700	2,700	2080	1556	1690	120
4–5	750	0.3	3,750	3,750	2280	1755	1880	150
6–7	1,050	0.42	4,800	4,800	2280	1985	2110	185
8–9	1,350	0.54	6,500	6,500	2390	2190	2390	220

Scope of supply: Carat RS underground tank, tank dome, telescopic dome shaft, one2clean system pack for one-tank system (>> page 74 – the GRAF modular system). Please order the air hoses separately (>> page 29). \*Total measurement

### Two-tank system one2clean / one2clean plus

Q Webcode G5105 Q Webcode G5114

Inhabitants [max.]	Max. daily flow [l/d]	Max. organic load [kg BOD <sub>5</sub> /d]	Total volume [l]	Volume [l]	Length* [mm]	Width* [mm]	Height [mm]	Weight [kg]
2–7	1,050	0.42	5,400	2 x 2,700	4760	1556	1690	240
8–10	1,500	0.6	7,500	2 x 3,750	5160	1755	1880	300
11–14	2,100	0.84	9,600	2 x 4,800	5160	1985	2110	370
15–18	2,700	1.08	13,000	2 x 6,500	5380	2190	2390	440

Scope of supply: Carat RS underground tanks, tank domes, telescopic dome shafts, one2clean system pack for two-tank system (>> page 74 – the GRAF modular system). Please order the air hoses separately (>> page 29). \*Total measurement

## Additional modules

+K and +D modules included

**+H** Hygiene modules

**+R** Remote transmission modules

**+P** Phosphate removal module

**+O** Pump-operated outlet module

**+C** Carbon infed module

>> page 24

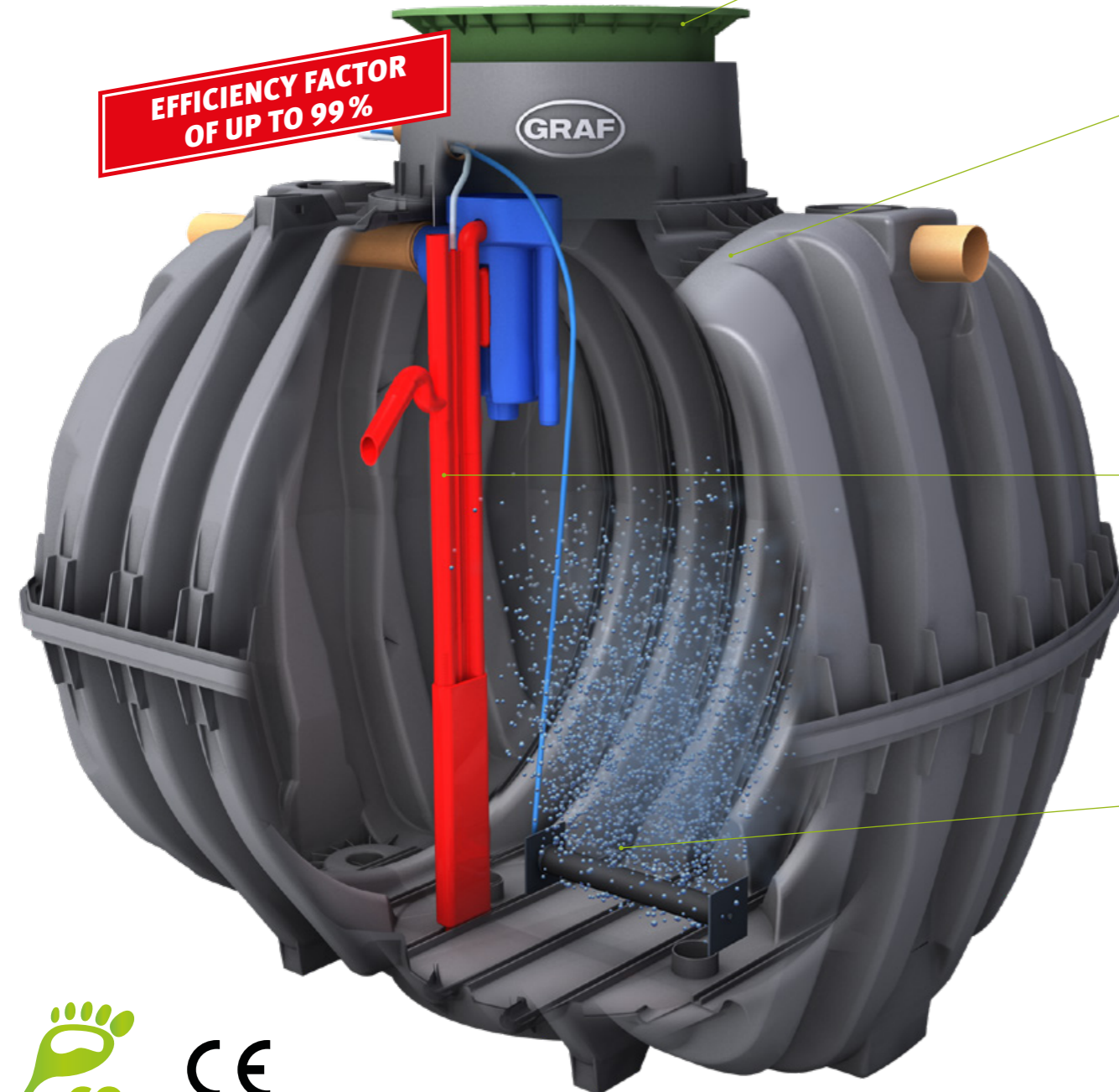

## Components and Benefits

### Covers

- Suitable for pedestrian or vehicle loading
- Adjustable in height
- Inclined up to 5°

» page 80

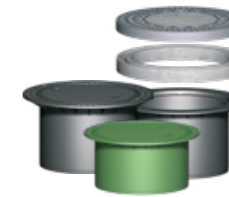

- ✓ Enables flash ground installation
- ✓ Nice looking cover
- ✓ Allows small corrections of height on-site
- ✓ Reduction of installation cost

### Wastewater tank

- State-of-the-art manufacturing for maximum stability
- 100% watertight and corrosion-resistant
- Can be mounted in groundwater
- Unique fit accuracy of the component

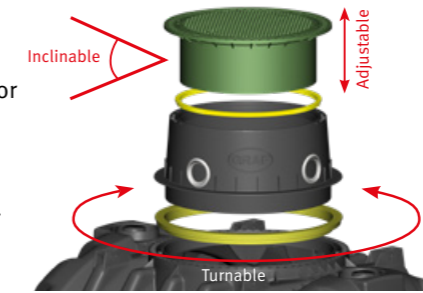

- ✓ Self-anchoring saves installation costs
- ✓ Up to 12 to loading, enables installation under car park (flexible choice of location)
- ✓ Tank made of 100% recycling material, environmentally friendly invest

### Installation kit

- Only one clear water lifter
- Rugged clear water lifter manufactured in one seamless piece
- Simple maintenance via an integrated, self-cleaning sampling container
- No electrical part in the tank



- ✓ Fast installation
- ✓ Saves installation costs
- ✓ Keeps service costs to a minimum
- ✓ Easy access for service company

### one2clean / one2clean plus control cabinets

- Simple handling thanks to micro-processor control
- Energy-saving
- Extremely quiet
- Battery-free power failure detection (for one2clean plus)
- Just one tank with one chamber needed



one2clean



one2clean plus

- ✓ Incredible cost saving due to very low power consumption
- ✓ System can be easily adjusted if required which will reduce costs for technician

Conventional wastewater treatment systems



- ✓ Incredibly little sewage sludge
  - Reduces running costs
  - Keeps environment clean
- ✓ Flexible selection of the control cabinet's position



# Klaro E Professional – Facts

16 – 50 PE (2,400 – 7,500 l/day)



## Why use the SBR system?

### How does SBR technology work?

Sequencing batch reactors or SBRs use a separate pre-treatment section to mechanically hold back solids and a biological aeration and settling tank. Small SBR wastewater treatment systems clean incoming wastewater over a number of cycles. GRAF products achieve a cleaning performance of up to 98%. In this respect the GRAF Klaro E Professional far surpasses legal minimum requirements.

- **Outstanding cleaning performance**  
Even during load fluctuations and underload
- **Excellent value for money**
- **Only 2 chambers required**
- **Only a small tank volume required**
- **Can be retrofitted in existing tanks**

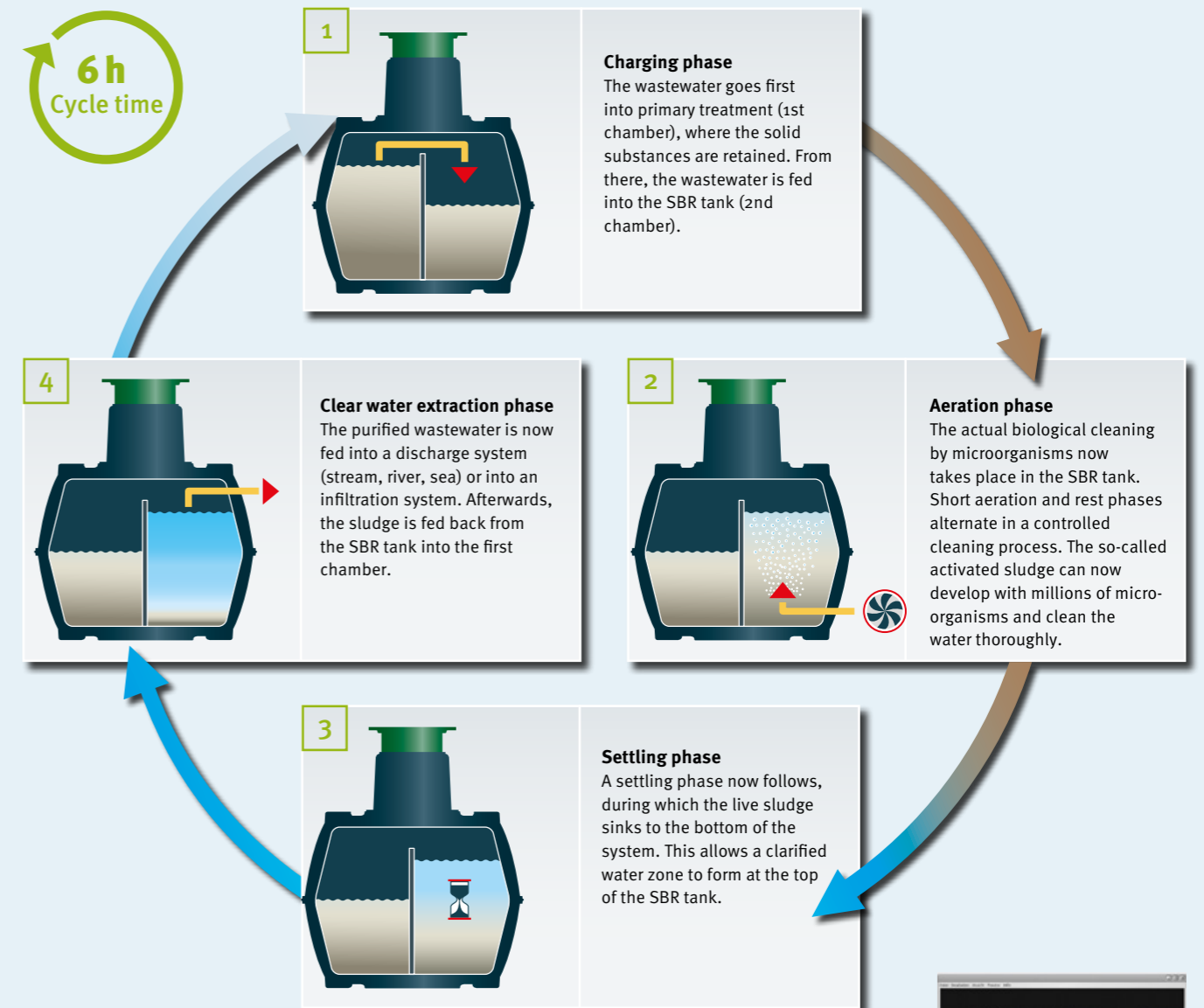

Function of the SBR wastewater treatment system Klaro

GRAF TV  
[www.graf-water.com/graf-tv](http://www.graf-water.com/graf-tv)

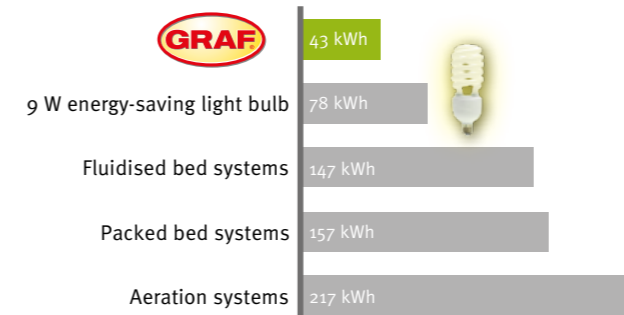

### Minimal power consumption per inhabitant<sup>1)</sup>

<sup>1)</sup>The diagram shows the annual power consumption of various treatment systems per inhabitant equivalent. Source: wwt magazine, edition 6/2007 "Die Kleinkläranlage als Dauerlösung", page 15, table 3, practical data; Klaro E Professional: Calculated running costs based on a 8 PE treatment plant.

# Klaro E Professional

Multitank system



**3**  
years  
warranty  
on technology

**15**  
years  
warranty  
on wastewater tanks

**QUALITY**  
MADE IN GERMANY



**Ideal for infiltration of cleaned wastewater**

>> page 88

## Technical data



System Klaro E Professional	KL24base	KL24plus
System conformity	EN 12566-3	EN 12566-3
Purifying technology	fully biological SBR lifting technology	fully biological SBR lifting technology
Multitank systems available up to	50 inhabitants   7,500 l/d	50 inhabitants   7,500 l/d
Maintenance interval	1 – 2 per year	1 – 2 per year
Warranty for underground tank	15 years	15 years
Warranty for purifying technology	3 years	3 years

Parameter	KL24base	KL24plus
COD (chemical oxygen demand)	91.9 %	93.1 %
BOD <sub>5</sub> (biochemical oxygen demand)	51 mg/l	47 mg/l
SS (suspended solids)	95.9 %	96.9 %
NH <sub>4</sub> -N	12 mg/l	11 mg/l
N <sub>total</sub>	65.6 %	74.7 %
P <sub>tot</sub>	57.1 %	69.9 %
eColi	–	94.5 %
		0.4 mg/l
		99.9 %
		–

Results of practical testing undertaken by the Prüfinstitut für Abwassertechnik (Testing Institute for Wastewater Technology), Aachen

## Accessories

>> page 24

## Klaro E Professional multitank system

Webcode G5103

Inhabitants [max.]	Max. daily flow [l/d]	Max. organic load [kg BOD <sub>5</sub> /d]	Total volume [l]	Volume [l]	Length* [mm]	Width* [mm]	Height [mm]	Weight [kg]
16 – 22	3,300	1.32	9600	2 x 4,800	5160	1985	2430	185
20 – 28	4,200	1.68	13,000	2 x 6,500	5380	2190	2710	220
25 – 32	4,800	1.92	15,000	4 x 3,750	10700	2000	2200	300
32 – 44	6,600	2.64	19,200	4 x 4,800	11100	2200	2430	370
42 – 50	7,500	3.00	26,000	4 x 6,500	11100	2200	2710	440

Scope of supply: Carat RS underground tanks, tank domes, telescopic dome shafts, Klaro E Professional system pack for multitank system (>> page 74 – the GRAF modular system). Please order the air hoses separately (>> page 31). \* Total measurement

## Additional modules

**+K** Convenience module

**+C** Carbon infeed module

**+O** Pump-operated outlet module

**+D** Denitrification module

**+H** Hygiene modules

**+B** Module buffer pump for short-term peak loads

**+P** Phosphate removal module

**+R** Remote transmission modules

>> page 24

# Klaro E Professional

The classic wastewater treatment technology

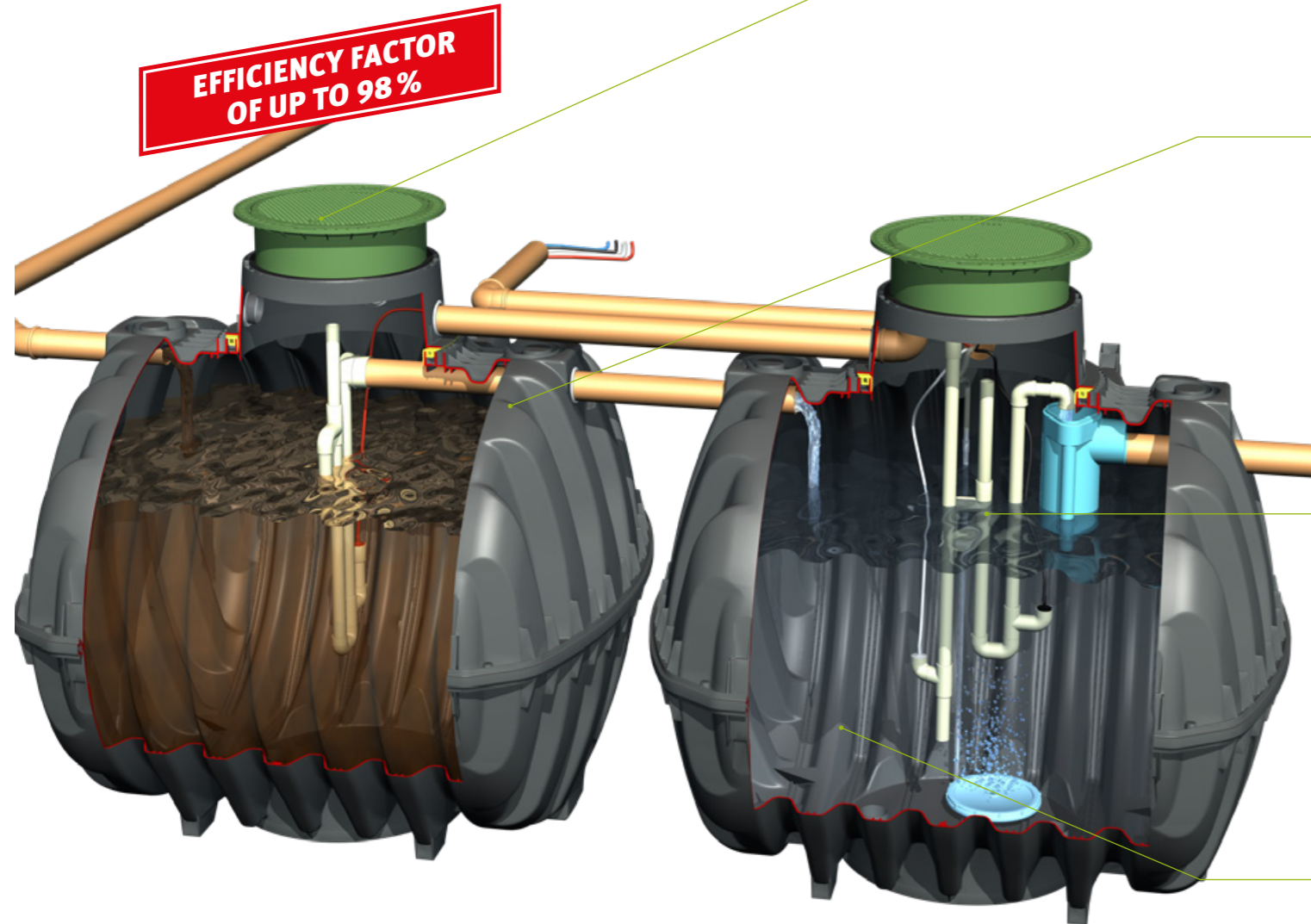

## Components and Benefits

### Covers

- Suitable for pedestrian or vehicle loading
- Adjustable in height
- Inclined up to 5°

>> page 80

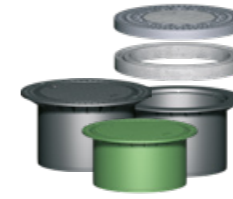

- ✓ Enables flash ground installation
- ✓ Nice looking cover
- ✓ Allows small corrections of height on-site
- ✓ Reduction of installation cost

### Wastewater tank

- State-of-the-art manufacturing for maximum stability
- 100% watertight and corrosion-resistant
- Can be mounted in groundwater
- Unique fit accuracy of the components

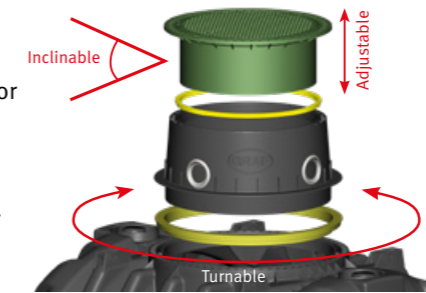

- ✓ Self-anchoring saves installation costs
- ✓ Up to 12 to loading, enables installation under car park (flexible choice of location)
- ✓ Tank made of 100% recycling material, environmentally friendly investment

### Installation kit

- Simple maintenance set-up kit can be easily installed and removed
- No electrical part in the tank
- Integrated air-lock-barrier prevent untreated water to enter the clearwater airlift
- Higher outflow through the tankdome can be realized



- ✓ Fast installation
- ✓ Saves installation costs
- ✓ Keeps service costs to a minimum
- ✓ Easy access for service company

### Klaro E Professional control cabinets

- Simple handling thanks to micro-processor control
- Energy-saving
- Extremely quiet
- Battery-free power failure detection



- ✓ Incredible cost saving due to very low power consumption
- ✓ System can be easily adjusted if required which will reduce costs for technician
- ✓ More comfortability at home (with KL24plus)
  - Automatic holiday mode
  - System adjust itself by changing life situation



# Klaro E Professional for retrofitting

5-50 PE (750 - 7,500 l/day)

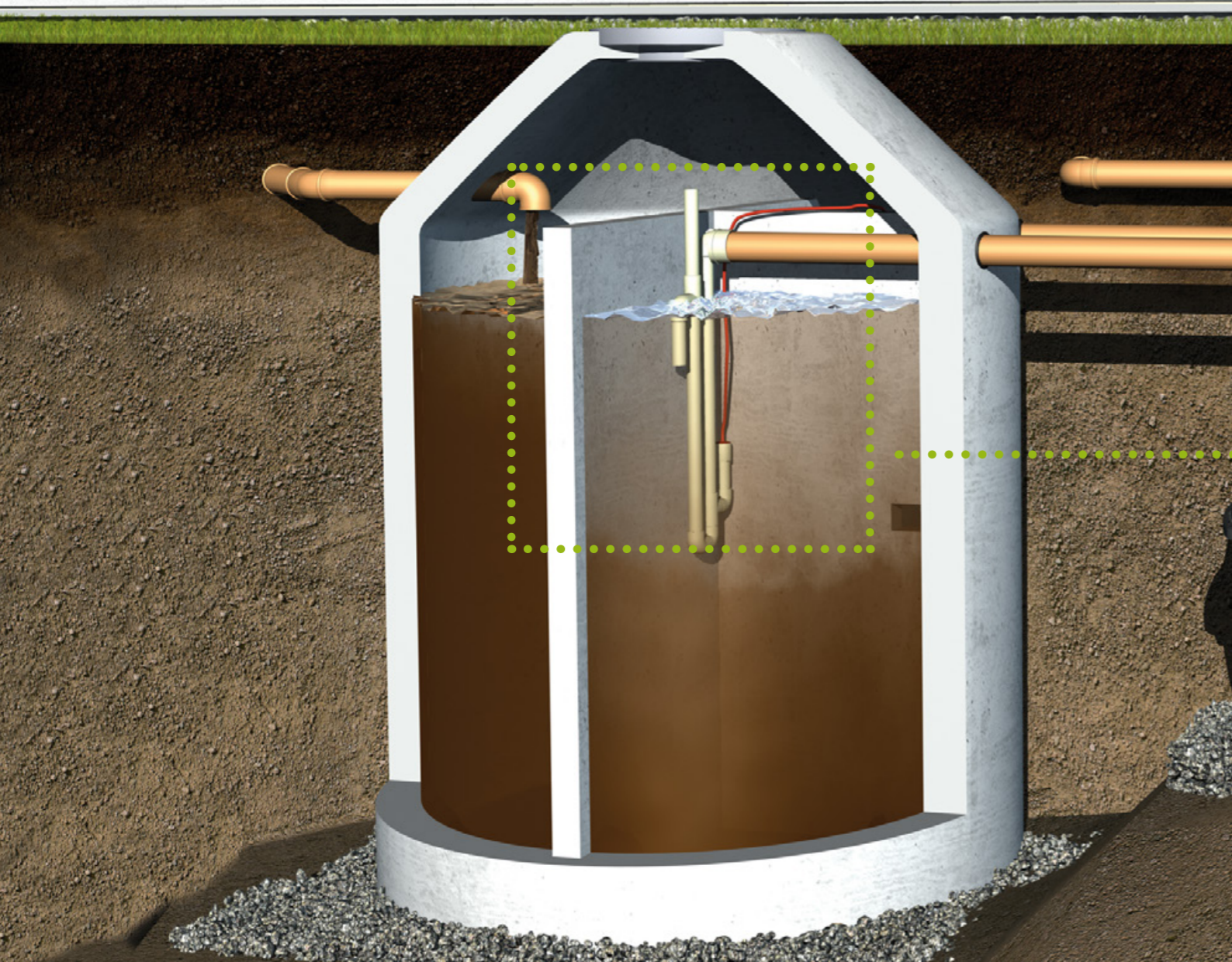

## Retrofitting – what needs to be done?

- Empty and clean pit
- Test tank to ensure leak-tightness / seal the baffle
- Measure existing pit: baffle height, diameter / depth dimensions
- Contact GRAF

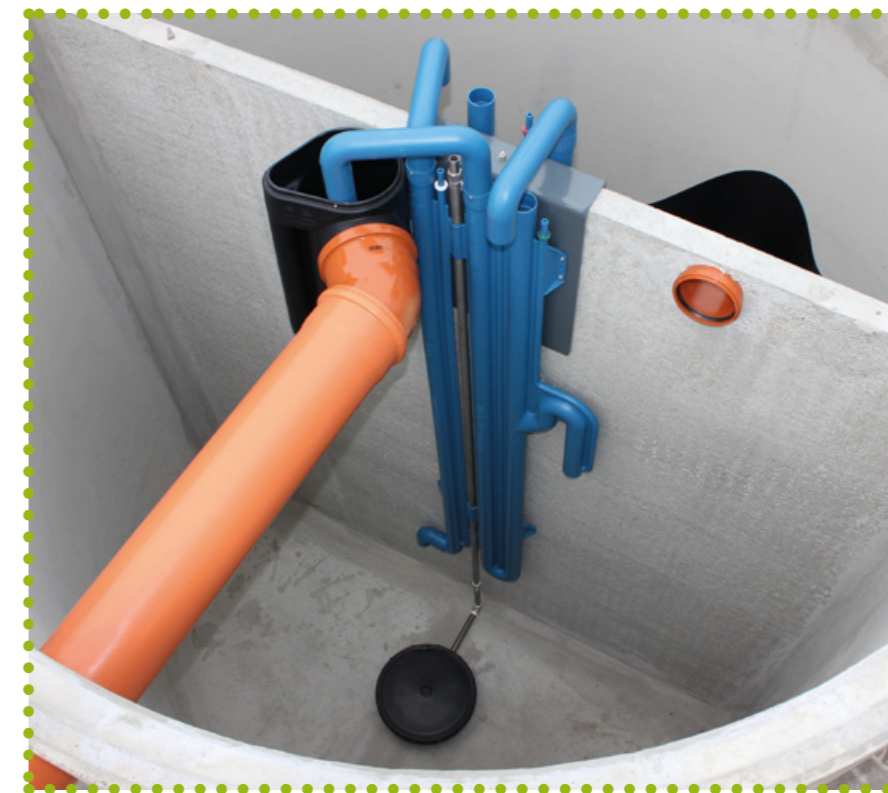

airlift.blue



**airlift.blue**  
System pack for retrofitting  
up to 28 inhab.  
Compressor as required  
On request

[Webcode G5201](#)

## Want to bring your multi-chamber pit bang up to date? Then get in touch!

The GRAF system packs allow existing tanks to be used with the proven GRAF Klaro E Professional.



Image shows System pack for retrofitting > 28 inhabitants)

## Our experienced team

takes all local circumstances into account to dimension your required system-pack

## +K Convenience module

Convenience module: control with larger display and keypad. Underload detection by a pressure sensor in the control.

### Control unit KL24plus



- SD card slot for easy logbook transfer
- Automatic underload detection
- Suitable for phosphate precipitation and UV module
- Large display and 14 keys for comfortable operation
- Automatic logging
- Battery-free power failure detection
- High-contrast display with blue backlighting
- Durable, gas-tight membrane keypad

On request

## +D Denitrification module

The +D module for denitrification (removal of nitrogen) results in the clarified water quality satisfying very strict requirements. The GRAF systems thereby attain a  $N_{total}$  value (total parameters of inorganic nitrogen compounds) of less than 25 mg/l.

Order no. 107520

## +C Carbon infed module

### Solution for weekend homes

The addition of carbon as a nutrient allows the purification process to continue and prevents the biology from dying off.

On request

## +P Phosphate removal module

Phosphate in water results in a massive build-up of algae. The GRAF +P module ensures the safe removal of phosphate and therefore great water quality

On request

## +B Module buffer pump for short-term peak loads

Only suitable for Klaro E Professional

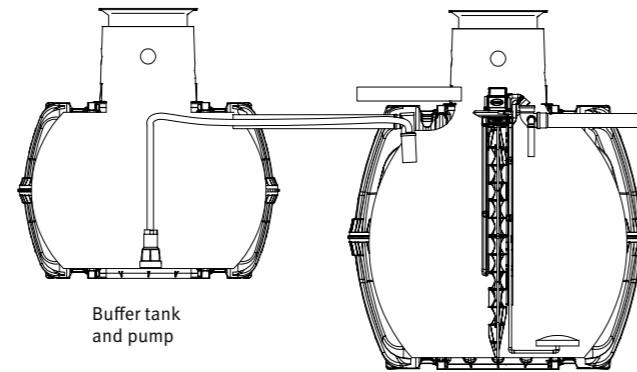

Buffer tank and pump

Klaro E Professional

On request

## +O Pump-operated outlet module

Lift the clear water when the outlet pipe is lower than the water course.

On request



### Fixing plate for canister (+P / +C)

Convenient positioning of the precipitant canister inside the tank dome (tank dome maxi required)

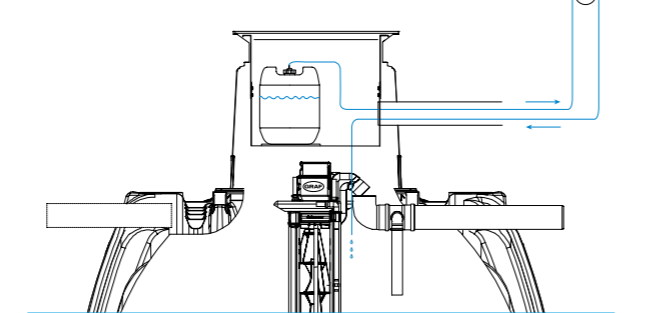

Order no. 107362



## +R Remote transmission modules

Remote monitoring allows error messages to be transmitted to mobile phones and operating data to be queried by text message. Convenient remote wastewater treatment system controlled by GSM (CSD, GRPS as option) or LAN is also possible.

- Greater efficiency
- Greater operating reliability
- Optimised service intervals
- Greater customer benefit thanks to monitoring service
- Low-cost remote diagnosis in the event of a fault without the service fitter having to come on site

On request

## +H Hygiene module – Disinfection

Disinfection using the +H module (by chlor or UV) satisfies even the most stringent of purity requirements for a GRAF wastewater treatment system. It reliably kills off germs and microorganisms. The clarified water therefore complies with the EU Bathing Water Directive.

On request

- Easy to operate
- Maintenance-friendly thanks to easy-to-remove module
- Fitted in downstream shaft

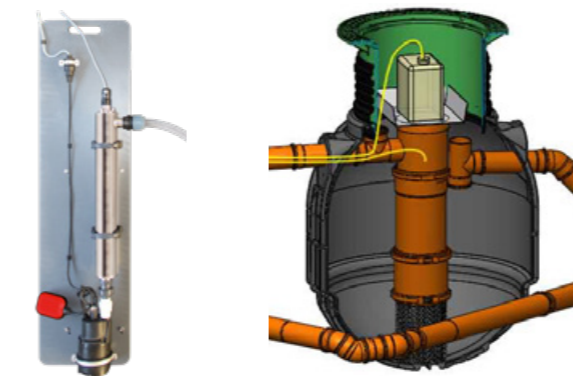

UV module

Chlor module

## +H Hygiene module – Sand filtration

In case of strict effluent quality requirements or high influent load variations, the GRAF sand filtration module is recommended to enhance and stabilize the purification performance of your sewage treatment system. The self cleaning dual media filtration system reduces suspended solids, COD and BOD of the secondary clarified effluent and may also serve to prevent debris in downstream installed storage or collection tanks for the re-use of wastewater.

On request

- Patented, simple and valve-free setup with automatic gravitationally driven backwash for minimal maintenance requirements
- Certified performance according to EN 12566-7
- Prefabricated plug and play system guarantees minimal work for piping and installation onsite
- Robust UV- and waterproof housing with lock for outside installation

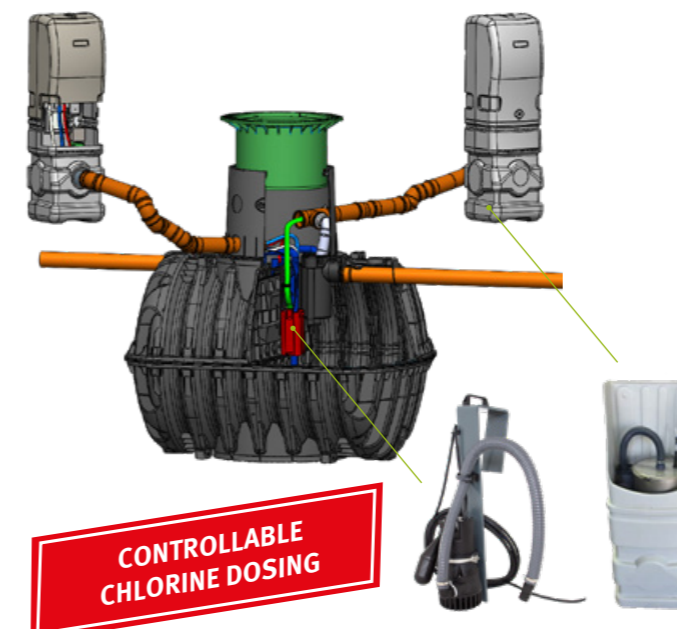

# Accessories: Re-use of wastewater bluecycle (Chlorination & Sand Filter)



## Wastewater re-use

Avoid the wastage of precious fresh water resources through the re-use of highly treated wastewater for outdoor purposes like gardening. We recommend you combine the advantages of GRAF sand filtration and GRAF chlorination subsequent to your GRAF biological sewage treatment plant for the safe re-use and storage of your treated wastewater.

- Reduction of suspended solids, COD and BOD followed by chemical disinfection
- Prevention of pathogen regrowth and fouling in water hoses and irrigation systems through the long-term effect of chlorine
- Filtration upstream of the disinfection stage reduces the chlorine demand effectively and prevents debris in the chlorine contact basin
- Certified performance according to EN 12566-7



## External plastic cabinet M

With auxiliary control and dosing pump for Chlorine module

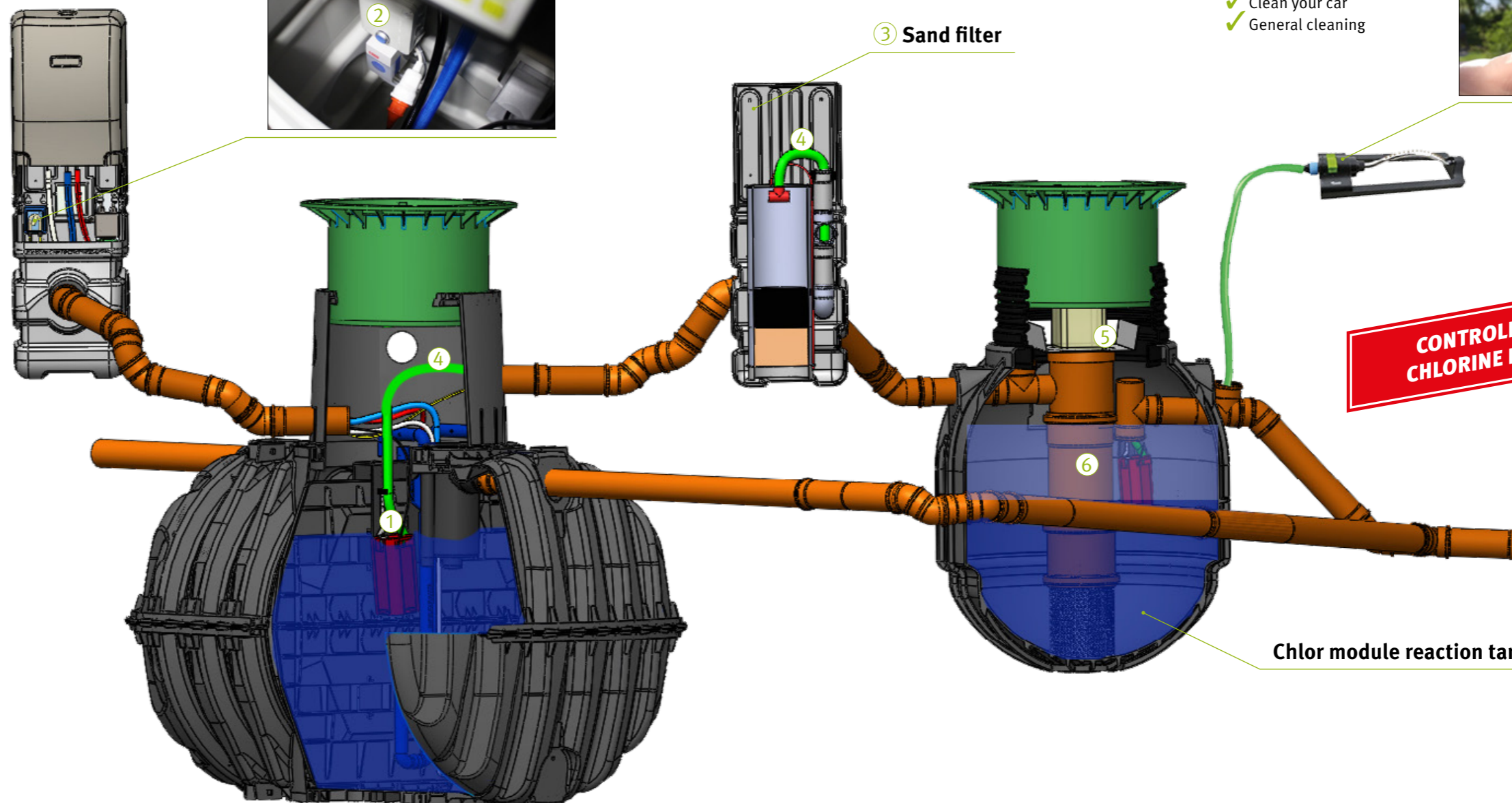

## Re-use for:

- ✓ Harvesting lawn and flowers
- ✓ Harvesting fruit and vegetable garden
- ✓ Clean your car
- ✓ General cleaning



**CONTROLLABLE CHLORINE DOSING**

## Bluecycle components:



- 1 Oxylift clearwater pump
- 2 Dosing pump with auxiliary control for Chlorine
- 3 Sand filter
- 4 5m Clearwater hose 1 1/4"
- 5 Tray for Chlorine canister
- 6 Reaction tank for tertiary treatment

## Chlorination with well available liquid sodium hypochlorite solution

- Safe and simple handling of the disinfection chemical
- Easy adjustment of the chlorine dosage pump to meet site-specific requirements
- Volume-proportional disinfectant dosing for low and stable chemical consumption
- Process kills near all the ecoli

Performance Results bluecycle	
eColi	99.9%
Total coliforms	99.9%

Results of practical testing undertaken by the Prüfinstitut für Abwassertechnik (Testing Institute for Wastewater Technology), Aachen

## bluecycle – re-use your treated water

- Up to 15 PE  
Order no. 106390
- Up to 20 PE  
Order no. 106574

# External Plastic Cabinet S

For one2clean



The image shows the External plastic cabinet S for 3 – 18 inhabitants

## Benefits

- ✓ Flexible application of the proven one2clean control cabinet in a plastic external column
- ✓ Weather-resistant plastic
- ✓ Edge seal for complete sealing over the ground
- ✓ High corrosion protection for the electrical parts
- ✓ Good value for money
- ✓ Easy assembly
- ✓ No foundation necessary

## External plastic cabinet S

For 3 – 18 inhabitants (up to 2,700 l/d)  
Order no. 107990



## Technical data

For air compressors	XP 60/80, HP 100-200
Upstream fuse	B16A (provided by customer)
Voltage supply	230 V AC ± 20 %, 50 Hz
IP	IP44
Relative air humidity	10 to 95 %
Temperature range	-25°C to +50°C
Total weight	7 kg (15.4 lbs)
Connecting line	via two-pin earthed plug

## Compatibility

one2clean	3 – 18 PE
-----------	-----------

# External Plastic Cabinet M

For one2clean/one2clean plus



The image shows the External plastic cabinet M for 3 – 18 inhabitants with LED warning light

## Benefits

- ✓ Easy access for the maintenance fitter
- ✓ Function checking is simple as the control unit is located immediately next to the system
- ✓ Ideal solution for large distances from the house (> 20 m)
- ✓ Flexible use of the proven GRAF EPP control cabinet in the External plastic cabinet L (size 3 – 18 inhabitants)
- ✓ Lockable housing in sturdy, weather-resistant plastic
- ✓ Integrated double power socket for easy maintenance
- ✓ No foundation necessary

## External plastic cabinet M

For 3 – 18 inhabitants (up to 2,700 l/d)  
Order no. 107773

## Technical data

For air compressors	LA 45 – 80, XP 60/80, HP 100 – 200
Upstream fuse	B16A (provided by customer)
Voltage supply	230 V AC ± 20 %, 50 Hz
IP	IP44
Relative air humidity	10 to 95 %
Temperature range	-25°C to +50°C
Total weight	10 kg (22 lbs)
Connecting line	via two-pin earthed plug

## Compatibility

one2clean	3 – 18 PE
one2clean plus	3 – 18 PE



## Accessories for small wastewater treatment systems

### Sampling point, internal

For two- and multitank systems ≤ 60 PE  
Order no. 107170



### Odour-tight empty pipe seal DN 100 for systems compatible with SBR-hose packages up to 28 PE

- Ensures no air, humidity or gas escapes from conduit pipe
- No need for PU seals
- Clean and professional solution

Order no. 107887



### SBR hose package

For one2clean / one2clean plus (one-tank systems)  
Includes: 1 x Ø 19 mm and 1 x Ø 13 mm  
PVC hose; colour-coded

Length: 10 m

Order no. 107686



Length: 20 m

Order no. 107688

Other SBR-hoses on request



### GRAF Handbook of Wastewater Treatment

More information about wastewater can be found in our Handbook of Wastewater Treatment.

# External Plastic Cabinet L

For Klaro E Professional



The image shows the External plastic cabinet L with LED warning light for 20 inhabitants

## Benefits

- ✓ Easy access for the maintenance fitter
- ✓ Function checking is simple as the control unit is located immediately next to the system
- ✓ Lockable housing (simultaneous locking) in sturdy, weather-resistant plastic
- ✓ Hose connections colour-coded
- ✓ No foundation necessary

## External plastic cabinet L

For 16 – 44 inhabitants (up to 6,600 l/d)

On request



## Technical data

For air compressors	LA 120, 200, DT 4.10, 4.16
Upstream fuse	B16A (provided by customer)
Voltage supply	230 V AC ± 20 %, 50 Hz
IP	IP 44
Relative air humidity	10 to 95 %
Temperature range	-25°C to +50°C
Total weight	22 kg
Connecting line	via two-pin earthed plug
Air compressor	230 V
Stepped motors	24 V

## Compatibility

Klaro E Professional	16 – 44 PE
----------------------	------------

## Accessories for small wastewater treatment systems

### Sampling point, internal

For two- and multitank systems ≤ 60 PE  
Order no. 107170



### Filling granulat for External plastic cabinet L

Prevents soil moisture from rising into the cabinet. 1 bag required; 50 l bag  
Order no. 107607



# External Steel Cabinet XL

For Klaro E Professional

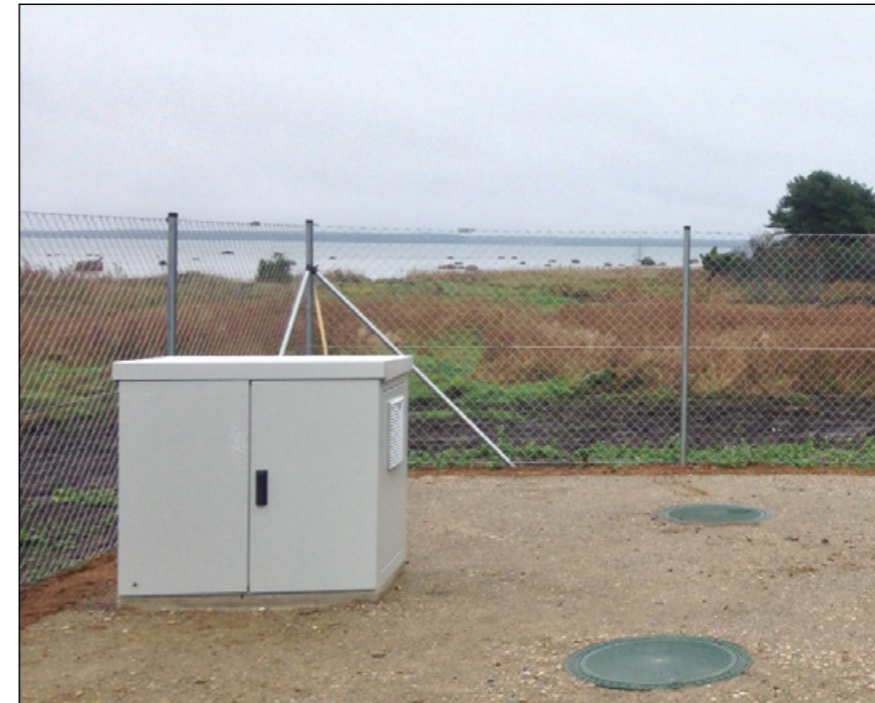

The image shows the External steel cabinet XL for 50 inhabitants

## Benefits

- ✓ Particularly robust design of powder coated steel sheet (1.5 mm / 0.005")
- ✓ Spray proof (IP 44)
- ✓ Lockable housing
- ✓ Hose connections colour-coded

## External steel cabinet XL

For 42 – 50 inhabitants (up to 7,500 l/d)  
On request

Solid foundation must be provided on-site.

## Technical data

For compressors	DT 4.25
External surfaces	Steel sheet 1.5 mm (0.005"), powder coated
Lock	Espagnolette lock (simultaneous locking), pivoted lever lock incl. profile half cylinder
Dimensions (W x H x D)	1140 x 1080 x 720 mm
Empty weight	140 kg

## Compatibility

Klaro E Professional	42 – 50 PE
----------------------	------------



### SBR hose package

For Klaro E Professional systems up to 28 PE  
Includes: 1 x Ø 19 mm and 3 x Ø 13 mm PVC hose; colour-coded

Length: 10 m

Order no. 107190

Length: 20 m

Order no. 107192

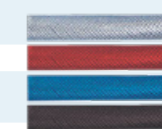

Other SBR-hoses on request



### GRAF Handbook of Wastewater Treatment

More information about wastewater can be found in our Handbook of Wastewater Treatment.



# Large Biological Wastewater Treatment Systems

- › one2clean plus XXL Page 36
- › Klaro L Page 38
- › Klaro XL Page 40
- › Klaro XXL Page 42
- › Klaro XXL Retrofitting Page 44
- › External Cabinets Page 46

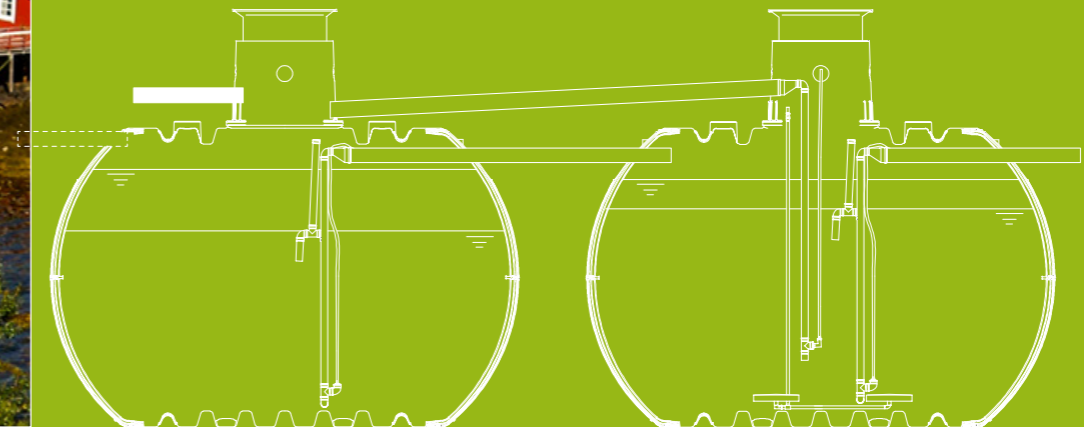

## System comparison



System	one2clean plus XXL	Klaro L   XL   XXL   XXL Retrofitting
Page	36/37	38-44
System conformity	EN 12566-3 / ATV A-122	ATV A-122
Purifying technology	fully biological SBR lifting technology	fully biological SBR lifting technology
Systems available up to	70 inhabitants   10,500 l/d	1500 inhabitants   225,000 l/d
Maintenance interval	2 - 4 per year	2 - 4 per year
Warranty for underground tank	15 years	15 years
Warranty for purifying technology	3 years	3 years
<b>Control</b>		
+D Removal of nitrogen	●	○
+P Phosphate removal	○	○
+C Carbon infeed	○	○
+H Disinfection	○	○
+R Remote transmission controlled by GSM (CSD, GPRS as option) or LAN	○	○
Control power failure recognition	●	●
Temperature sensor to protect against overheating	●	●
Logbook function	●	●
Operation	14 keys	14 keys
Serial interface for software updates	●	●
External control cabinet for installing control unit outdoors	○	○

● Standard equipment   ○ Available as options

# one2clean plus XXL

24–70 PE (3,600–10,500 l/day)



**15**  
years  
warranty

on wastewater tanks

**3**  
years  
warranty

on technology



Download [www.graf.info](http://www.graf.info)  
sizing form

Ideal for infiltration of cleaned wastewater



>> page 88

## one2clean plus XXL system – fully prefitted in the Carat XXL underground tank [Q Webcode G5115](#)

Inhabitants [max.]	Volume [litres]	Max. daily flow [l/d]	Max. organic load [kg BOD <sub>5</sub> /d]	Required air hoses [quantity x Ø mm]	Length* [m]	Width* [m]	Order no.
24	16,000	3,600	1.44	2 x 19	4.66	2.50	106261
32	22,000	4,800	1.92	2 x 19	6.15	2.50	106262
45	32,000	6,750	2.7	2 x 19	8.53	2.50	106264
50	38,000	7,500	3.0	2 x 19	10.01	2.50	106265
60	44,000	9,000	3.6	4 x 19	11.50	2.50	106064
70	48,000	10,500	4.2	5 x 25	12.40	2.50	106359

Scope of supply: Carat XXL underground tank, tank domes maxi, telescopic dome shafts, factory pre-fitted technology and control cabinet for internal fitting. Air hoses are not included and must be ordered separately. \*Total measurements



External plastic cabinet L for 24–32 PE

>> page 46



External steel cabinet XL for 45–70 PE

>> page 46

### Sampling point, internal

For multitank systems ≤ 60 PE

Order no. 107170



### Sampling point, external Universal shaft 600

For multitank system ≥ 60 PE

Order no. 330136



### Covers

• Suitable for pedestrian or car loading

>> page 80



### Filling granulat for External plastic cabinet L

Prevents soil moisture from rising into the External plastic cabinet L. 1 bag required for 24–32 inhabitants; 50 l bag required for 24–32 inhabitants; 50 l bag

Order no. 107607



### Additional modules

+K and +D modules included

**+H** Hygiene modules

**+P** Phosphate removal module

**+C** Carbon infeed module

**+R** Remote transmission module

>> page 24

# Klaro L

60 – 180 PE (9,000 – 27,000 l/day)



Ideal for infiltration of cleaned wastewater



>> page 88

**15** years warranty on wastewater tanks

**3** years warranty on technology

**QUALITY** MADE IN GERMANY

## Technical data

<b>System</b>	Klaro L
System conformity	ATV A-122
Purifying technology	fully biological SBR lifting technology
Multi-tank systems available up to	180 inhabitants   27,000 l/d
Maintenance interval	3 – 4 per year
Warranty for underground tank	15 years
Warranty for purifying technology	3 years

## Klaro L system for the Carat RS underground tank

Q Webcode G5106

Inhab. [max.]	Max. daily flow [l/d]	Max. organic load [kg BOD <sub>5</sub> /d]	Total number of tanks	Primary treatment [capacity in l]	SBR tank [capacity in l]	Required air hoses [quantity x Ø mm]	Length* [m]	Width* [m]
60	9,000	3.60	4	2 x 6,500	2 x 6,500	6 x 19	11.10	2.20
90	13,500	5.40	5	2 x 6,500	3 x 6,500	9 x 19	11.10	4.90
120	18,000	7.20	7	3 x 6,500	4 x 6,500	12 x 19	11.10	4.90
150	22,500	9.00	9	4 x 6,500	5 x 6,500	14 x 19	14.00	4.90
180	27,000	10.80	10	4 x 6,500	6 x 6,500	16 x 19	11.10	7.60

Scope of supply: Carat RS underground tanks tank domes maxi, telescopic dome shafts, system pack Klaro L and control cabinet for internal fitting. The air hoses from the underground tanks to the control panel are not included.

\*Total measurements (>> page 74 – the GRAF modular system)



**External steel cabinet XL**  
For 60 – 150 inhabitants

>> page 46

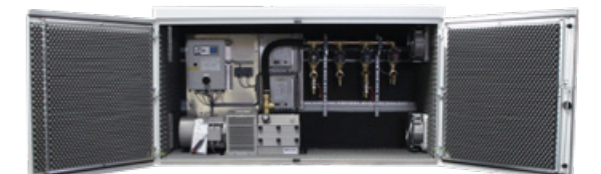

**External steel cabinet XXL**  
For 160 – 200 inhabitants

>> page 47

### Sampling point, external Universal shaft 600

For multitank system ≥ 60 PE  
Order no. 330136



### Extension 300 mm

For universal shaft 600  
Order no. 371003



### Covers

• Suitable for pedestrian or car loading  
>> page 80



### Compact dosing pump

0 – 37 ml/min  
Order no. 107348



## Additional modules

+K module included

**+D** Denitrification module

**+H** Hygiene modules

**+P** Phosphate removal module

**+R** Remote transmission modules

**+C** Carbon infed module

>> page 24

# Klaro XL

38 – 200 PE (5,700 – 30,000 l/day)

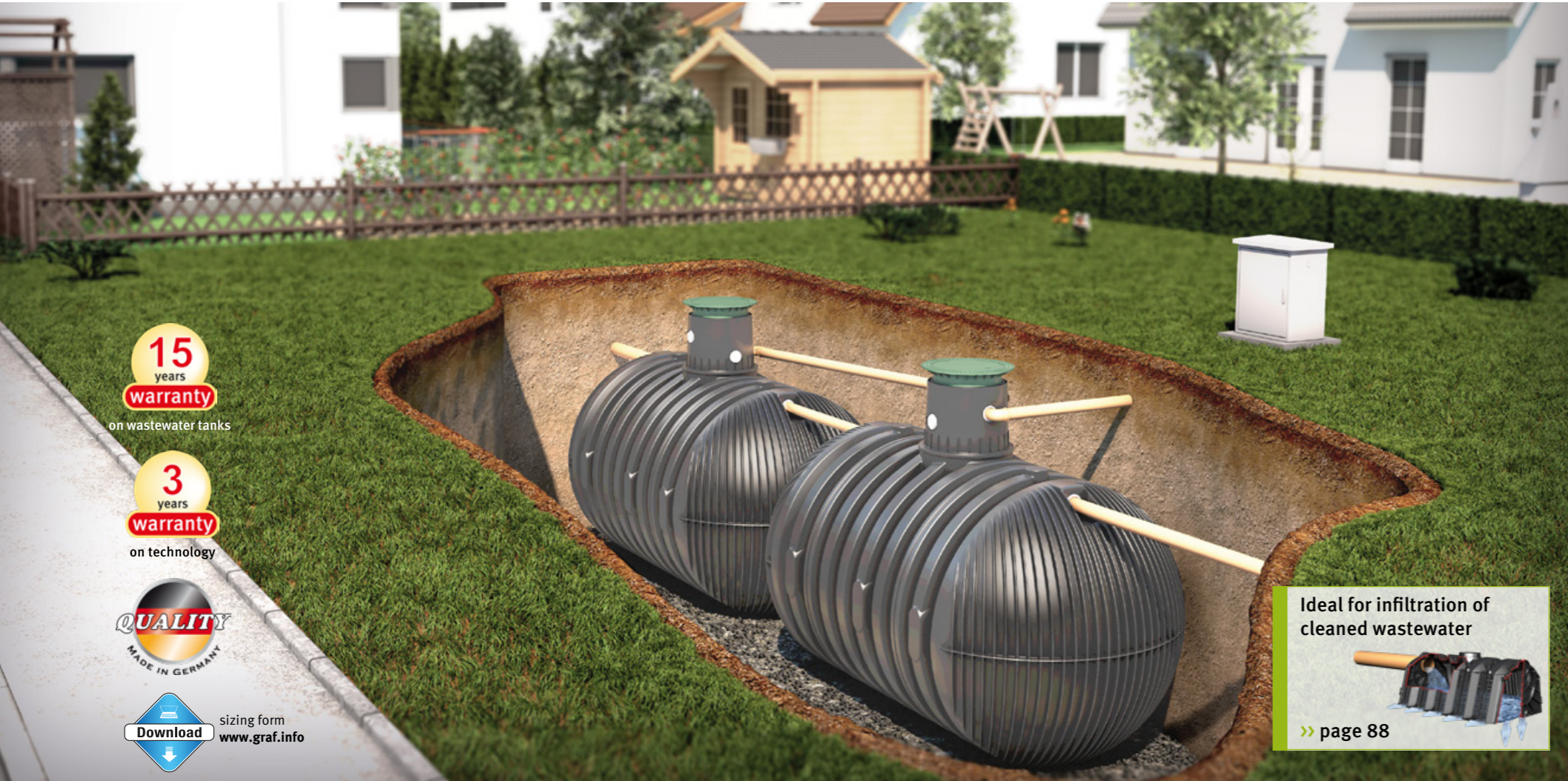

**15**  
years  
warranty  
on wastewater tanks

**3**  
years  
warranty  
on technology



Download sizing form  
www.graf.info

Ideal for infiltration of cleaned wastewater  
  
» page 88

## Technical data

System	Klaro XL
System conformity	ATV A-122 > 50 PE
Purifying technology	fully biological SBR lifting technology
Multi-tank systems available up to	200 inhabitants   30,000 l/d
Maintenance interval	2 – 4 per year
Warranty for underground tank	15 years
Warranty for purifying technology	3 years

## Klaro XL system – fully prefitted in the Carat XL underground tank

Webcode G5108

Inhab. [max.]	Max. daily flow [l/d]	Max. organic load [kg BOD <sub>5</sub> /d]	Total number of tanks	Primary treatment [capacity in l]	SBR tank [capacity in l]	Required air hoses [quantity x Ø mm]	Length* [m]	Width* [m]	Order no.
38**	5,700	2.28	2	1x8,500	1x8,500	3 x 19	7.50	2.04	107755
46**	6,900	2.76	2	1x10,000	1x10,000	3 x 19	7.54	2.24	107756
80	12,000	4.80	4	2 x 8,500	2 x 8,500	6 x 19	15.50	2.04	106172
100	15,000	6.00	4	2 x 10,000	2 x 10,000	6 x 19	15.58	2.24	106173
120	18,000	7.20	5	2 x 8,500	3 x 8,500	9 x 19	11.50	7.12	106174
145	21,750	8.70	5	2 x 10,000	3 x 10,000	9 x 19	11.56	7.72	106175
165	24,750	9.90	7	3 x 8,500	4 x 8,500	12 x 19	7.50	9.66	106176
200	30,000	12.00	7	3 x 10,000	4 x 10,000	12 x 19	7.54	10.46	106177

Scope of supply: Carat XL underground tanks, tank dome maxi, telescopic dome shafts, factory pre-fitted technology and control cabinet for internal fitting. The air hoses from the underground tanks to the control panel are not included.

\*Total measurements \*\*Only removal of carbon



External plastic cabinet L  
For 38 – 46 inhabitants

» page 46



External steel cabinet XL  
For 80 – 145 inhabitants

» page 46



External steel cabinet XXL  
For 180 – 200 inhabitants

» page 47

**Sampling point, internal**  
For multitank systems ≤ 60 PE  
Order no. 107170



**Sampling point, external  
Universal shaft 600**  
For multitank system ≥ 60 PE  
Order no. 330136



**Extention 300 mm**  
For universal shaft 600  
Order no. 371003



**Covers**  
• Suitable for pedestrian or car loading  
» page 80



## Additional modules

+K module included

**+D** Denitrification module

**+H** Hygiene modules

**+P** Phosphate removal module

**+R** Remote transmission modules

**+C** Carbon infed module

» page 24

# Klaro XXL

75 – 1000 PE (11,250 – 150,000 l/day)

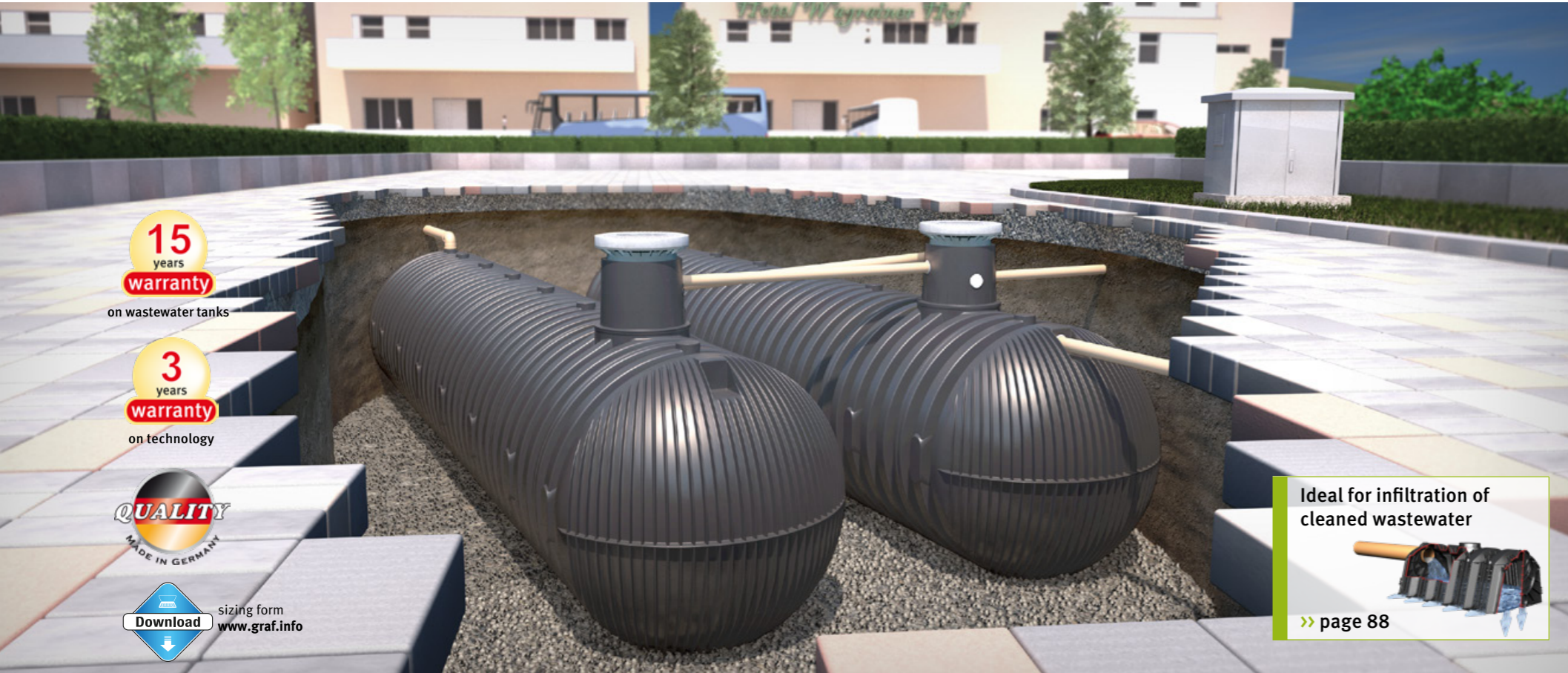

## Technical data

System	Klaro XXL
System conformity	ATV A-122 > 50 PE
Purifying technology	fully biological SBR lifting technology
Multi-tank systems available up to	1000 inhabitants   150,000 l/d
Maintenance interval	3 – 4 per year
Warranty for underground tank	15 years
Warranty for purifying technology	3 years

## Klaro XXL system – fully prefitted in the Carat XXL underground tank

Q Webcode G5109

Inhabitants [max.]	Max. daily flow [l/d]	Max. organic load [kg BOD <sub>5</sub> /d]	Primary treatment [capacity in l]	SBR tank [capacity in l]	Required air hoses [quantity x Ø mm]	Length* [m]	Width* [m]	Order no.
75	11,250	4.50	1x 16,000	1x 16,000	3x 19, 1x 25	9.90	2.50	106125
100	15,000	6.00	1x 22,000	1x 22,000	5x 19	12.90	2.50	on request
150	22,500	9.00	1x 32,000	1x 32,000	6x 25	17.70	2.50	106106
200	30,000	12.00	2x 22,000	2x 22,000	10x 25	26.40	2.50	106970
250	37,500	15.00	1x 52,000	2x 32,000	12x 25	13.30	8.70	106049
300	45,000	18.00	1x 52,000	2x 32,000	12x 25	13.30	8.70	106050
350	52,500	21.00	3x 22,000	2x 38,000	12x 25	19.90	5.60	on request
400	60,000	24.00	3x 22,000	2x 44,000	18x 25	21.40	5.60	on request
450 / 500	75,000	30.00	3x 22,000	4x 32,000	24x 25	27.50	5.60	on request
550 / 600	90,000	36.00	3x 26,000	4x 32,000	24x 25	16.20	11.80	on request
650 / 700	105,000	42.00	1x 42,000 2x 32,000	4x 38,000	24x 25	27.50	5.60	on request
750 / 800	120,000	48.00	1x 38,000 3x 22,000	6x 28,000	30x 25	26.20	8.70	on request
850 / 900	135,000	54.00	1x 54,000 3x 22,000	6x 34,000	36x 25	29.10	8.70	on request
950 / 1000	150,000	60.00	1x 54,000 3x 22,000	6x 28,000	36x 25	30.50	8.70	on request

Scope of supply: Carat XXL underground tank, tank domes maxi, telescopic dome shafts, factory pre-fitted technology and control cabinet for internal fitting. The air hoses from the underground tanks to the control panel are not included. \*Total measurements



External steel cabinet XL  
For 75 – 150 inhabitants

» page 46

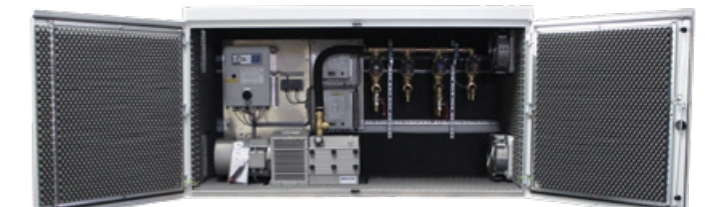

External steel cabinet XXL  
For 200 – 1000 inhabitants

» page 47

## Accessories

### Sampling point, external Universal shaft 600

For multitank system ≥ 60 PE  
Order no. 330136



### Extention 300 mm

For universal shaft 600  
Order no. 371003



### Covers

• Suitable for pedestrian or car loading  
» page 80



### Compact dosing pump

0 – 37 ml/min

Order no. 107348



## Additional modules

+K module included

**+D** Denitrification module

**+P** Phosphate removal module

**+C** Carbon infed module

**+H** Hygiene modules

**+R** Remote transmission modules

» page 24

# Klaro XXL Retrofitting for Onsite Concrete Tanks

100 – 1500 PE (15,000 – 225,000 l/day)

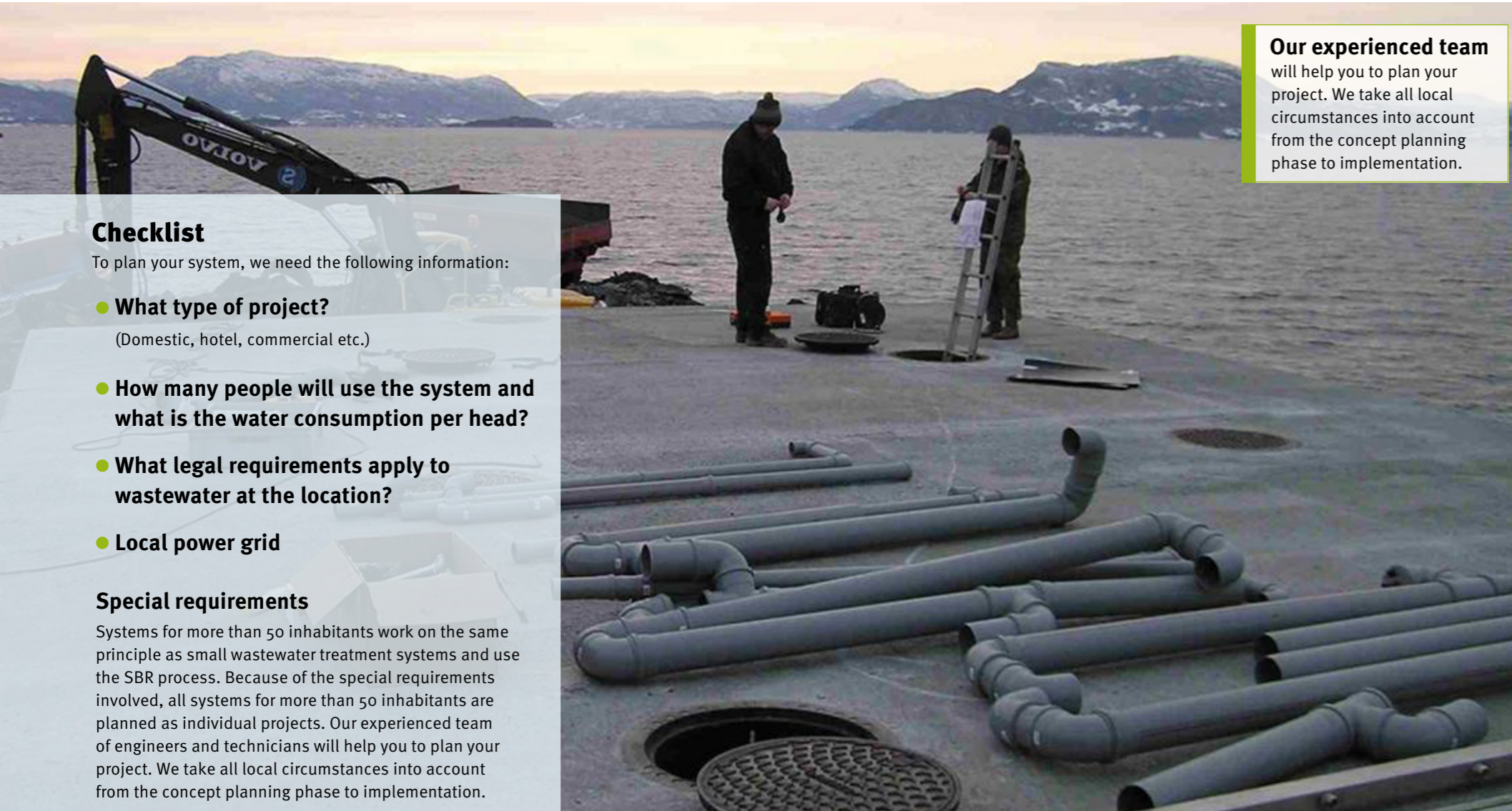

**Our experienced team** will help you to plan your project. We take all local circumstances into account from the concept planning phase to implementation.

## Checklist

To plan your system, we need the following information:

- **What type of project?**  
(Domestic, hotel, commercial etc.)
- **How many people will use the system and what is the water consumption per head?**
- **What legal requirements apply to wastewater at the location?**
- **Local power grid**

## Special requirements

Systems for more than 50 inhabitants work on the same principle as small wastewater treatment systems and use the SBR process. Because of the special requirements involved, all systems for more than 50 inhabitants are planned as individual projects. Our experienced team of engineers and technicians will help you to plan your project. We take all local circumstances into account from the concept planning phase to implementation.

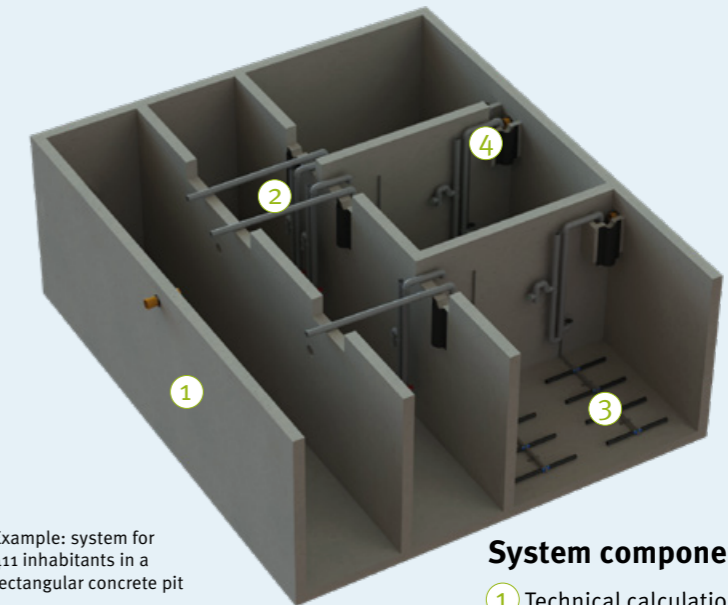
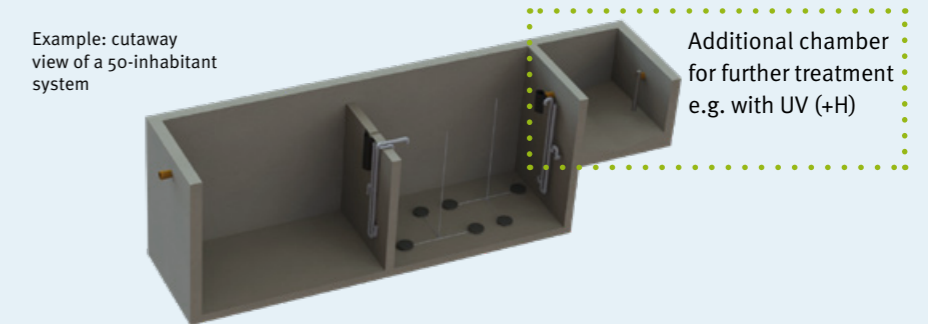

## System components

- ① Technical calculation for pit size
- ② Air lifts
- ③ Aerator unit
- ④ Outflow with sampling point

## Klaro XXL Retrofitting for onsite concrete tanks

Webcode G5206

Inhabitants [max.]	Max. daily flow [m³/d]	Max. organicload [kg BOD <sub>5</sub> /d]	Water depth [mm]	Sludge / buffer [m]	SBR chamber [m]	Compressor
100	15	6.00	2500	2.80 x 2.90	2.80 x 2.90	DTN 41
200	30	12.00	2750	2.80 x 5.40	2.80 x 5.40	KDT 3.80
300	45	18.00	3000	2.80 x 7.50	2.80 x 7.50	KDT 3.100
400	60	24.00	3000	5.50 x 4.90	5.50 x 4.90	KDT 3.140
500	75	30.00	3000	5.50 x 6.40	5.50 x 6.40	KDT 3.140
600	90	36.00	3000	5.80 x 6.60	2 x 2.80 x 7.50	2 x KDT 3.100
700	105	42.00	3000	11.20 x 3.90	2 x 5.50 x 4.30	2 x KDT 3.100
800	120	48.00	3000	11.20 x 4.50	2 x 5.50 x 4.90	2 x KDT 3.140
900	135	54.00	3000	11.20 x 5.00	2 x 5.50 x 5.50	2 x KDT 3.140
1000	150	60.00	3000	11.20 x 5.60	2 x 5.50 x 6.40	2 x KDT 3.140

Further sizes up to 1500 PE on request

## External cabinets and further accessories

>> page 46

## Machine technique

As an alternative to a conventional control cabinet, the technical components can be installed in a dedicated room or machine house. This guarantees sufficient space for all the necessary components and maximum flexibility.



Example: Installation in a machine house



Example: Installation in an existing plant room

# External Cabinets

For one2clean plus XXL, Klaro L | XL | XXL



## External plastic cabinet L

- ✓ Easy access for the maintenance fitter
- ✓ Function checking is simple as the control unit is located immediately next to the system
- ✓ Lockable housing (simultaneous locking) in sturdy, weather-resistant plastic
- ✓ Hose connections colour-coded
- ✓ No foundation necessary

On request



## External steel cabinet XL

- ✓ Particularly robust design of powder coated steel sheet (1.5 mm / 0.005")
- ✓ Spray proof (IP 44)
- ✓ Lockable housing
- ✓ Hose connections colour-coded

On request

Solid foundation must be provided on-site.



## External steel cabinet XXL

- ✓ Particularly robust design of powder coated steel sheet (1.5 mm / 0.005")
- ✓ Spray proof (IP 44)
- ✓ Lockable housing
- ✓ Hose connections colour-coded

For 165 – 1,000 inhabitants  
(up to 150,000 l/d)

On request

Solid foundation must be provided on-site.

## Technical data

For air compressors	LA 120, 200, DT 4.10, 4.16	DTN 41, KDT 3.60, KDT 3.80	KDT 3.100, 3.140
Upstream fuse	B16A (provided by customer)	B16A (provided by customer)	B16A (provided by customer)
Voltage supply	230 V AC ± 20 %, 50 Hz	380 VAC, 3~, 50 Hz	380 VAC, 3~, 50 Hz
IP	IP44	IP44	IP44
Relative air humidity	10 to 95 %	10 to 95 %	10 to 95 %
Temperature range	-25°C to +50°C	-25°C to +50°C	-25°C to +50°C
Total weight	22 kg	140 kg	210 kg
Connecting line	via two-pin earthed plug	via four-pin earthed plug	via four-pin earthed plug
Air compressor	230 V	380 V	380 V
Stepped motors	24 V	24 V	24 V
External surfaces	Plastic	Steel sheet 1.5 mm, powder coated	Steel sheet 1.5 mm, powder coated
Lock	Espagnolette lock (simultaneous locking), pivoted lever, lock incl profile half cylinder	Espagnolette lock (simultaneous locking), pivoted lever lock incl profile half cylinder	Espagnolette lock (simultaneous locking), pivoted lever lock incl profile half cylinder
Dimensions (W x H x D)	480 x 1750 x 340 mm	1140 x 1080 x 720 mm	2000 x 1100 x 900 mm

## Compatibility

one2clean plus <b>XXL</b>	24 – 32 PE	45 – 70 PE	–
Klaro L	–	60 – 150 PE	180 PE
Klaro XL	38 – 46 PE	80 – 145 PE	165 – 200 PE
Klaro XXL	–	75 – 150 PE	200 – 1000 PE
Klaro XXL retrofitting	–	on request	on request

## Accessories

### Filling granulate for External plastic cabinet L

Prevents soil moisture from rising into the cabinet; 1 bag required 50 litre bag

Order no. 107607



### Warning light

LED warning light for mounting on External plastic cabinet L. Including assembly material

Order no. 107861



### Warning light

LED warning light for mounting on External steel cabinet XL / XXL. Including assembly material

Order no. 107961



### SBR hose Ø 19 mm, 20 m roll

transparent Order no. 934692

red Order no. 934693

blue Order no. 934020

black Order no. 934694



### SBR hose Ø 25mm

transparent Order no. 934002



# container.blue

> container.blue

Page 50

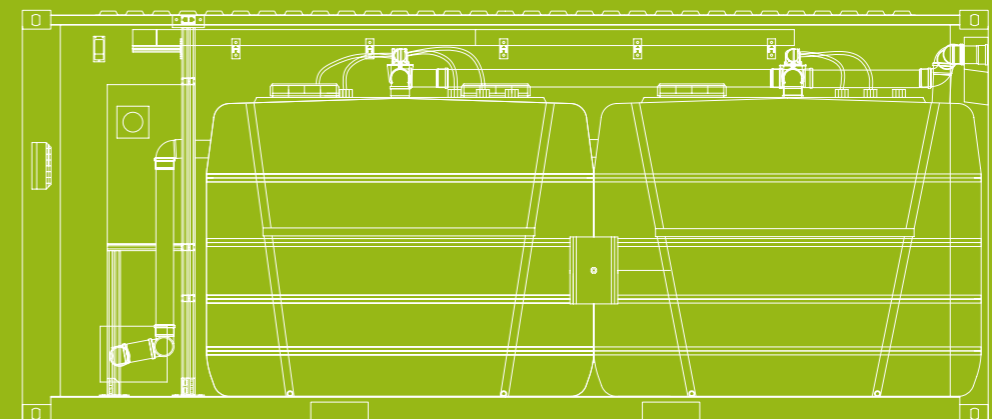



container.blue systems are suitable for

- ✓ Working camps
- ✓ Mining camps
- ✓ Military camps
- ✓ Quarries
- ✓ Logging camps
- ✓ Temporary works
- ✓ Research camps

Technical data

General system data	
Equipment	20 ft side door container
Material	Steel
Weight (tare)	3180 kg
Dimensions	(L) 6058 mm; (B) 2114 mm; (H) 2169 mm
Inlet	DN 110; height 2310 mm
Outlet	DN 110; height 415 mm
Ventilation	DN 110; height 2310 mm
Operating voltage	400 V, 50 Hz (60 Hz)
Rated current	32 A
Temperature range	-10°C to +35°C
Power consumption	10 – 12 kWh/d

Wastewater treatment data	
Inflow volume	10 m <sup>3</sup> /d, more on request
BOD <sub>5</sub> load	4 kg/d (60gBOD <sub>5</sub> /inhab.*d)
Operating time	24 h
Operation	Automatic

Process quality	
SS (suspended solids)	< 30 mg/l
BOD <sub>5</sub> (biochemical oxygen demand)	< 10 mg/l
COD (chemical oxygen demand)	< 20 mg/l
NH <sub>4</sub> -N	< 10 mg/l
N <sub>total</sub>	< 20 mg/l

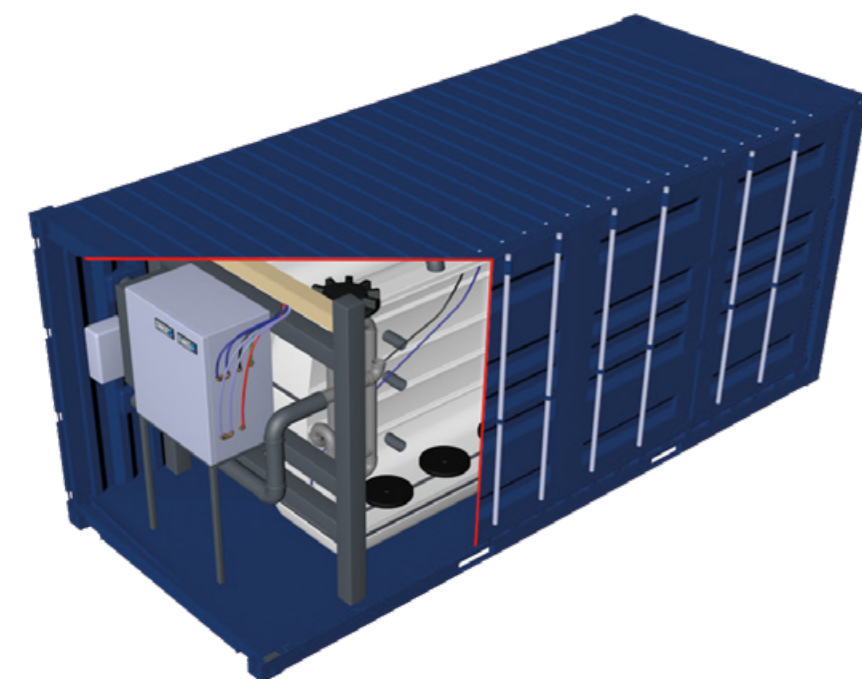

PIA, independent testing institute in Aachen

**container.blue**  
20 ft container; up to 10,000 l/d  
Order no. 160000

Webcode G5116

Benefits container.blue

- ✓ Easy to transport (standard 20 ft container)
- ✓ Prefabricated, expandable design
- ✓ Rapid assembly and disassembly
- ✓ Low power consumption (1.2 kWh per 1,000 l water treated)
- ✓ Virtually odourless thanks to vented tanks
- ✓ Parallel connection for larger volumes of wastewater
- ✓ Less maintenance knowledge needed
- ✓ Plug & play, ready for immediate use

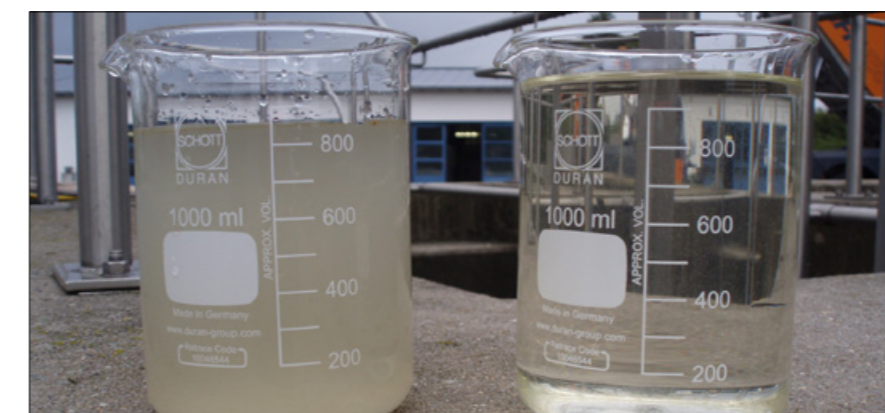

Raw wastewater

Effluent water

Cleaning performance

The cleaning performance was established in a practical field test lasting several weeks. The system was gradually filled with untreated domestic wastewater. In this case, the maximum filling quantity amounted to 10 m<sup>3</sup> per day. The notified testing institute for wastewater technology (PIA GmbH) determined the cleaning performance at the test location by taking samples of the inflow and outflow.

# Powerless Wastewater Treatment Systems

› Biomatic system	Page 56
› Anaerobix	Page 58
› Anaerobix XL/XXL	Page 60
› Carat RS Septic tank	Page 62
› Cesspools	Page 63
› Herkules Septic Tank and Cesspool	Page 65

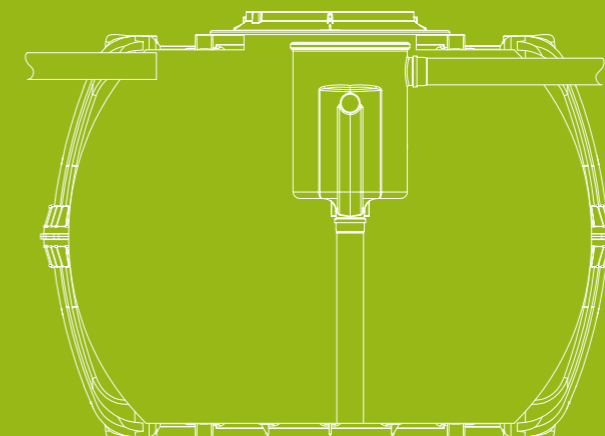

## System comparison

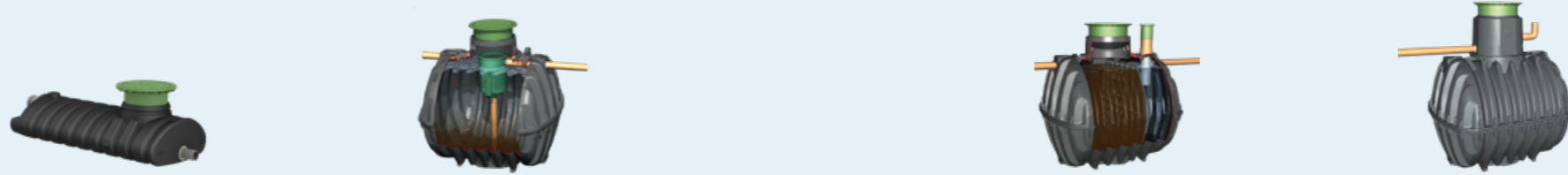

System	Biomatic	Anaerobix / Anaerobix XL / Anaerobix XXL	Septic Tanks	Cesspools
Page	56/57	58-61	62/65	63-65
System conformity	EN 12566-3	—	EN 12566-1	—
Purifying technology	Sand filter bed	anaerobic process	mechanical separation	—
Warranty for underground tank	15 years	15 years	15 years	15 years

Limit values	30l / 40l / 60l			
BOD <sub>5</sub> (biochemical oxygen demand)	97.5 %	75 %	50-65 %	—
SS (suspended solids)	96.7 %	90 %	60-70 %	—



Anaerobix



Carat RS



Carat XL



Carat XXL



Herkules



Platin

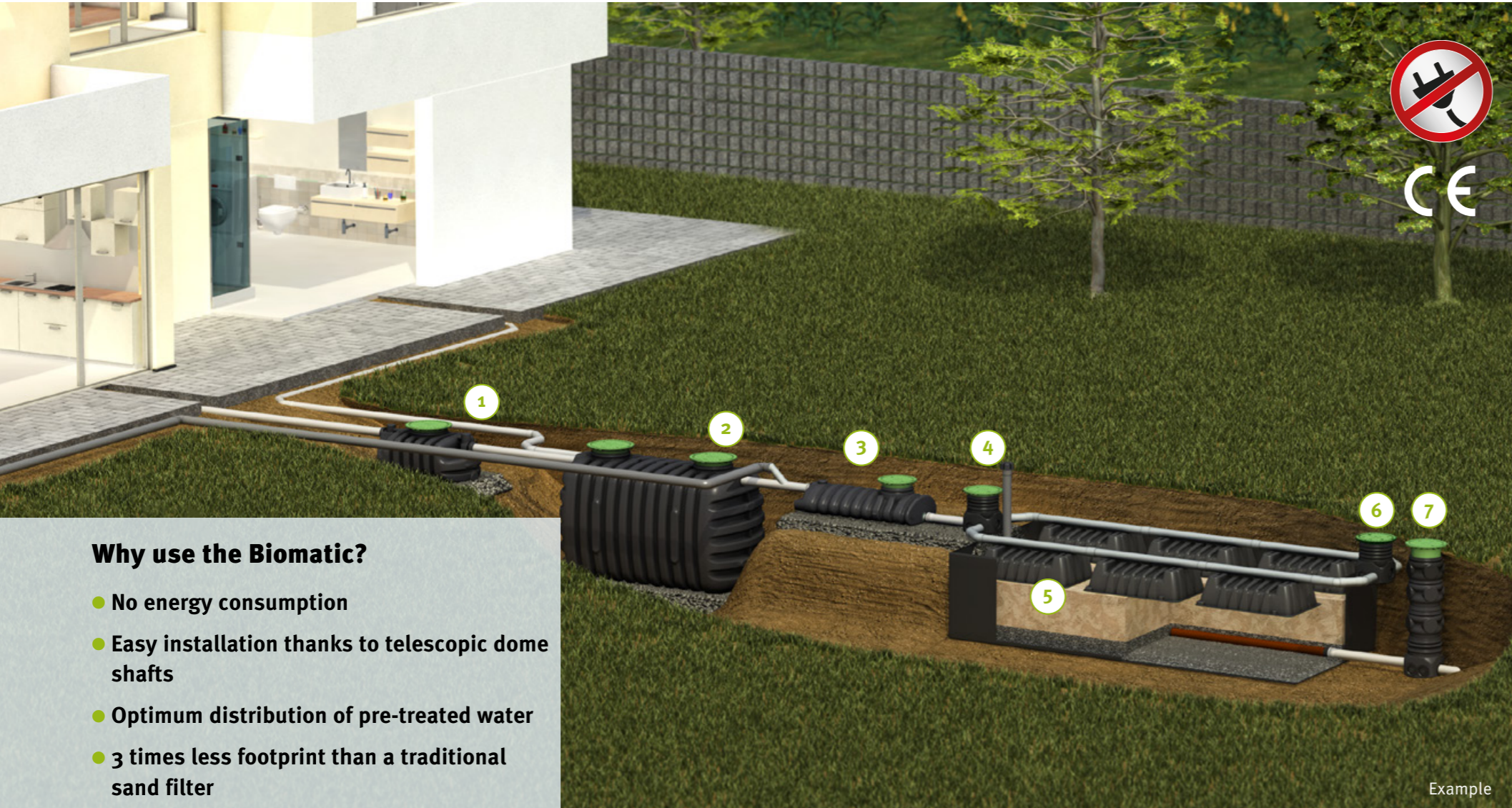

## Why use the Biomatic?

- No energy consumption
- Easy installation thanks to telescopic dome shafts
- Optimum distribution of pre-treated water
- 3 times less footprint than a traditional sand filter

## How does Biomatic work?

The Biomatic compact filter is a compact, stand-alone sanitation solution that works on the principle of traditional sectors. This solution,

composed of 100% GRAF products, operates in a gravitational manner and without electricity. The Biomatic modules making up the treatment

system stand out from traditional sand filters because of their compactness (less than 11 m<sup>2</sup> for 6 PE).

## Biomatic system

Webcode G5117

Inhab. [max.]	Max. daily flow [l/d]	Max. organic load [kg BOD <sub>5</sub> /d]	Pre-treatment Volume [litres]	Length* [mm]	Width* [mm]	Height* [mm]	Weight** [kg]	Order no.
6	900	0.36	3,750	2590	2590	1380	260	106398
12	1,800	0.72	6,500	3890	5580	1380	440	106399

\* Total measurement

\*\*without pre-treatment septic tank

## Technical data

System	Biomatic system
System conformity	EN 12566-3
Purifying technology	sand filter bed
Maintenance interval	1 – 2 per year
Warranty for underground tank	15 years

Parameter	Cleaning performance for Klaro E Professional	
COD (chemical oxygen demand)	92.3 %	62 mg/l
BOD <sub>5</sub> (biochemical oxygen demand)	97.5 %	7 mg/l
SS (suspended solids)	96.7 %	7 mg/l
NH <sub>4</sub> -N	78.8 %	12 mg/l

Results of practical testing undertaken by the Centre Scientifique et Technique du Bâtiment (CSTB), Nantes

- ① Greas separator (optional 1l / sec.)
- ② Carat RS 3,750 l / 6,500 l incl. Anaerobix 60 l
- ③ Batch feeding tank 50 l (6 PE), 100 l (12 PE)
- ④ Distribution shaft
- ⑤ Biomatic modules / filter bed
- ⑥ Ventilation / maintenance shaft
- ⑦ Collector shaft

## Simple Transport due to optimized packaging



Function of the Biomatic system

GRAF TV  
www.graf-water.com/graf-tv

# Anaerobix

GRAF Wastewater Treatment System with Biological Filter



Ideal for infiltration of cleaned wastewater  
 >> page 88



## The benefits of the Anaerobix system at a glance

- ✓ Very good cleaning performance: efficiency over 90 %, PIA-tested (Testing Institute for Waste Water Technology)
- ✓ No power consumed, no electrical or mechanical components (e.g. pumps or float switch) in tank
- ✓ Largely maintenance-free
- ✓ Installation in proven Graf tanks
- ✓ Easy to install with standard DN 100 pipes
- ✓ Very good value for money

## Simple and low-cost

- Anaerobix is the low-cost anaerobic filter system for GRAF wastewater tanks
- Filled with the carrier material supplied, it increases the cleaning performance of a wastewater tank

several times over. The large surface of the recyclable plastic carrier material (141 m<sup>2</sup>/m<sup>3</sup>) allows the biofilm responsible for the cleaning process to cover a large area.

## Anaerobix single-tank system

Q Webcode G5507

Inhab. [max.]	Max. daily flow [l/day]	Tank	Anaerobix Typ [l]
1-2	150-300	Saphir 600 l	30
2-3	150-450	Saphir 900 l	30
2-3	300-450	Erdtank 1,000 l	30
2-3	300-600	Saphir 1,200 l	30
3-4	450-750	FLAT 1,500 l	30
4-5	450-750	Cristall 1,600 l	40
5-8	750-1,200	Cristall 2,650 l	40
8-9	750-1,350	Carat RS 2,700 l*	60
10-12	1,050-1,800	Carat RS 3,750 l*	60
12-16	1,350-2,400	Carat RS 4,800 l*	60
16-21	1,950-3,150	Carat RS 6,500 l*	60
2	300	Herkules 1,600 l	integrated

Scope of supply: Graf wastewater tank (tank dome and telescopic dome shaft), Anaerobix filter.  
 \* (> page 74 - The GRAF modular system)



PIA, independent testing institute in Aachen

## Technical data



System Anaerobix	Herkules	30 l   40 l   60 l
Purifying technology	Anaerobic system	Anaerobic system
One-tank systems available up to	300 l/d	3,150 l/d
Maintenance interval	1-2 per year	1-2 per year
Warranty for underground tank	10 years	-

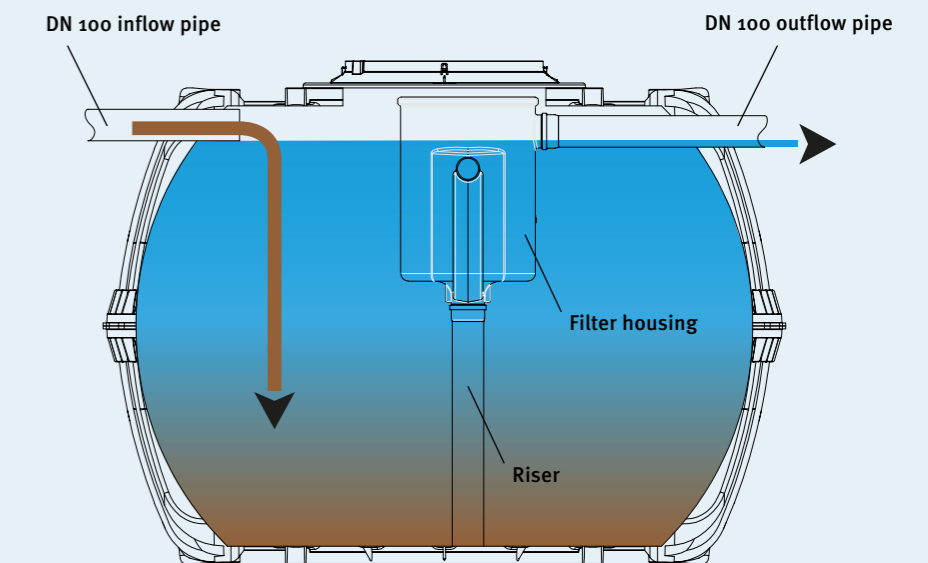
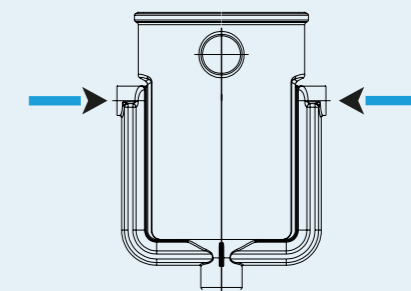

Limit values	Herkules	30l/40l/60l
BOD <sub>5</sub> (biochemical oxygen demand)	56,6 %	75 %
SS (suspended solids)	81 %	90 %



800 PE, Panama



Pre-chamber septic tank

Anaerobix Carat

Final sedimentation tank

## Anaerobix XL

[Q. Webcode G5505](#)

Inhab. [max.]	Anaerobix tank	Required vol. for pre-treatment septic tank [l]	Max. daily flow [l/d]	Carrier material [m³]	Qty. of bags [0,05 m³ / bag]	Order no.
22-33	Erdtank 1,000 l	10,000	4,950	0,75	15	107696
33-53	Cristall 1,600 l	16,000	7,950	1,5	30	107697
53-88	Cristall 2,650 l	32,000	13,200	2,4	48	107698

Scope of supply: GRAF underground tank, tank dome, telescopic dome shafts and Anaerobix XL Filter.

## Anaerobix XXL

[Q. Webcode G5506](#)

Inhab. [max.]	Anaerobix tank	Required vol. for pre-treatment septic tank [l]	Max. daily flow [l/d]	Carrier material [m³]	Qty. of bags [0,05 m³ / bag]	Order no.
200	1x Carat RS 6,500 l	60,000	30,000	6	100	on request
400	2x Carat RS 6,500 l	120,000	60,000	12	200	on request
600	3x Carat RS 6,500 l	180,000	90,000	18	300	on request
800	4x Carat RS 6,500 l	240,000	120,000	24	400	on request

Further sizes on request

Scope of supply: Carat RS underground tanks, tank domes, telescopic dome shafts, accessory set for pre treatment septic tanks, accessory set for Anaerobix XXL Filter and carrier material.

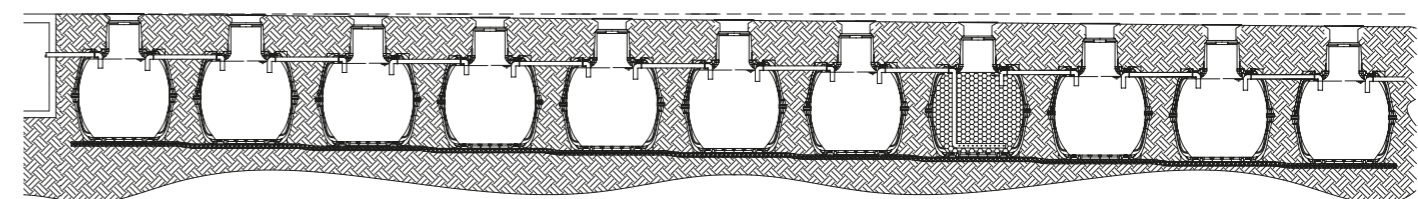
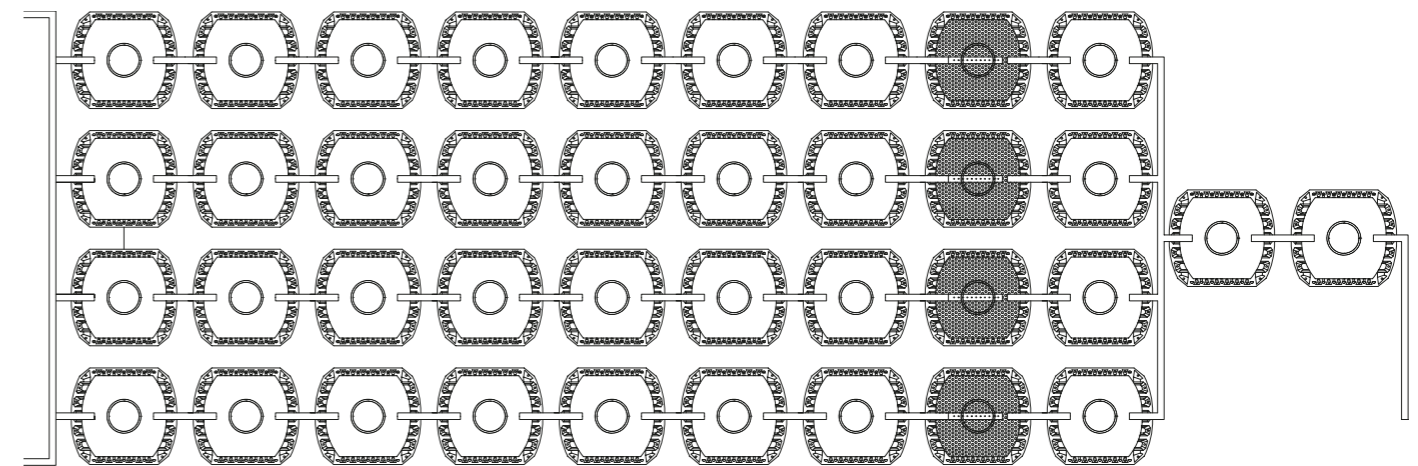

# Carat RS Septic Tank

Three chambers / Two chambers / One chamber

## Benefits

- ✓ Up to 45 wastewater tanks per lorry
- ✓ Low weight: can also be installed in difficult local conditions without a crane
- ✓ Reasonable purchase and installation costs. Compare!
- ✓ Low maintenance: maintenance or cleaning work can be performed through the shafts
- ✓ Tanks can be used as rainwater harvesting systems after thorough cleaning

Floating and removable material is extracted from domestic wastewater in mechanical wastewater tanks. This is purely mechanical cleaning.



Ideal for infiltration of cleaned wastewater

>> page 88

## 12566-1\*

Hydraulic efficiency 99.9%

\*Refer to the installation instructions for CE-compliant Septic tanks

## Carat RS Septic tank

Q Webcode G5504

Inhabitants [max]	Total volume [l]	Capacity [l]	Length [mm]	Width [mm]	Height [mm]	Weight [kg]
5	2,700	2,700	2080	1565	2010	145
7	3,750	3,750	2280	1755	2200	175
9	4,800	4,800	2280	1985	2430	220
13	6,500	6,500	2390	2190	2710	260

Scope of supply: Carat RS underground tank with baffle. Also available without baffle as a one-chamber wastewater tank. (>> page 80 – suitable covers >> page 82 – different baffle position)

## Accessories

### Inspection end DN 200

For Carat RS 4,800 l and 6,500 l

Order no. 340527



### Deaeration end DN 100

Order no. 369017



Presenting the Carat wastewater tank

GRAF TV  
www.graf-water.com/graf-tv



# Cesspools



## Benefits

- ✓ Easy installation due to low net weight
- ✓ The tank can also be used as a rainwater collection tank after cleaning
- ✓ Can be expanded as required.
- ✓ Self-anchoring



## Carat RS Cesspool (>> page 80 – suitable covers)

Q Webcode G5408

Volume [l]	Length [mm]	Width [mm]	Height [mm]	Weight [kg]
2,700	2080	1565	2010	120
3,750	2280	1755	2200	150
4,850	2280	1985	2430	185
6,500	2390	2190	2710	220

## Carat XL Cesspool (>> page 80 – suitable covers)

Q Webcode G5409

Volume [l]	Length [mm]	Width [mm]	Height [mm]	Weight [kg]
8,500	3500	2040	2695	380
10,000	3520	2240	2895	456

## Carat XXL Cesspool (>> page 80 – suitable covers)

Q Webcode G5410

Volume [l]	Length [mm]	Width [mm]	Height [mm]	Weight [kg]
16,000	4660	2500	2550	805
36,000	9430	2500	2550	1495
56,000	14200	2500	2550	2185
76,000	18970	2500	2550	2875

Other sizes >> page 85 / up to 122.000 litres on request

## Accessories

### Overflow guard

Emits visual and audio alarm, battery-operated (9 V).

Order no. 351017



### Odour filter for ventilation shaft

Reliably filters out unpleasant odours.

Order no. 104018



### Special seal DN 100

For connections

Order no. 332033

### Drill DN 100

With view shaft

Order no. 202003



# Cesspools

## Benefits

- ✓ Can be installed in groundwater
- ✓ Shallow installation
- ✓ Easy installation due to low net weight
- ✓ The tank can also be used as a rainwater collection tank after cleaning.
- ✓ Can be expanded as required

## Volume

Volume [l]	Order no.
1,500	390000
3,000	390001
5,000	390002
7,500	390005



# Herkules Septic Tank / Cesspool

For overground and underground installation



## Benefits

- ✓ Stability tested according to European standard (DIN EN 12566-3)
- ✓ Construction approved by DIBt for domestic wastewater
- ✓ Can be installed in groundwater
- ✓ Fits through any door (80 cm) – each half-shell weighs just 30 kg
- ✓ Fast tank fitting with profile seal and fast connectors
- ✓ Tanks can be used for rainwater harvesting systems after thorough cleaning
- ✓ Can be expanded as required

## Herkules tank 1,600 l

Order no. 320001

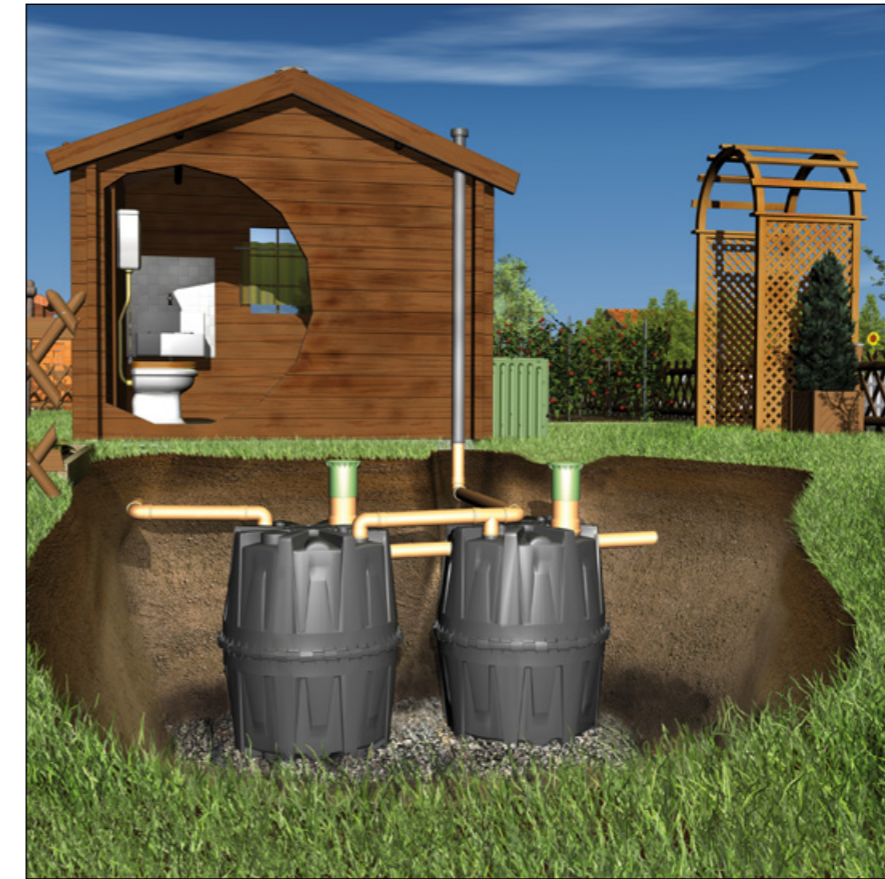

## Platin Cesspool

Q Webcode G5411

Volume [l]	Width B [mm]	Length L [mm]	Height H [mm]	Height H <sub>tot</sub> [mm]	Height of dome shaft ht [mm]	Internal Ø of dome shaft [mm]	Weight [kg]
1,500	1250	2100	700	1015	315	650	82
3,000	2100	2450	735	1050	315	650	180
5,000	2300	2890	950	1265	315	650	250
7,500	2250	3600	1250	1565	315	650	360

## Technical data

Max. earth covering (without groundwater vehicle loading)	1200 mm
Max. axle load	2.2 t
Max. total weight	3.5 t
Earth covering required for vehicle loading	700 mm – 1000 mm
Groundwater stability	up to tank shoulder
Earth covering required for groundwater stability	700 mm – 1200 mm
Connection	4 x DN 100

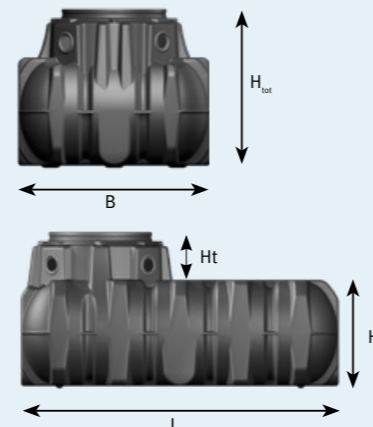

## Technical data

Q Webcode G5406

Total volume [l]	Volume [l]	Height [mm]	Ø max. [mm]	Weight [kg]
Herkules – Septic tank (three chambers)				
4,800	1,600	1600	1350	60
	1,600	1600	1350	60
Herkules – Septic tank (two chambers)				
3,200	1,600	1600	1350	60
	1,600	1600	1350	60
Herkules – Septic tank (one chamber)				
1,600	1,600	1600	1350	60
Herkules – Cesspool				
1,600	1,600	1600	1350	60

## Unbeatable advantages:

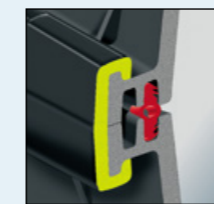

**Long-lasting**  
Durably sealed thanks to solid profile sealing (seal lifetime of more than 25 years proven in laboratory tests)

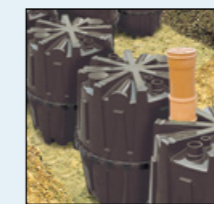

**Can be extended as desired**  
Shape-matched end connectors and connection surfaces enable volumes of several 10,000 l

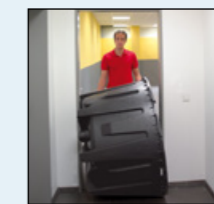

**Easy transport**  
Thanks to low weight of 30 kg per half-shell and practical size; fits through all doorways (up to 80 cm)



**Stackable**

## Accessories

**Tank dome DN 200**  
With telescopic end, length 1 m  
Order no. 322026

**Extension set**  
2 x seal DN 100 without connection pipe  
Order no. 202028

**Drill DN 100**  
With view shaft  
Order no. 202003



# Separators

- › Grease separator
- › Light fluid separator

Page 68

Page 70

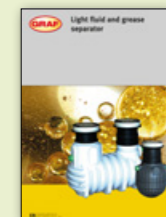
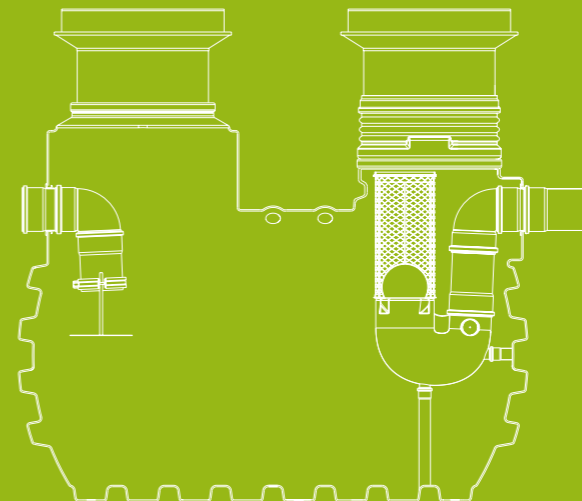

**More information**  
Can be found in our light fluid and grease separator salesfolder.



In operations where wastewater contains grease, it must be treated 'separately' using a separator before being discharged to the sewer system. A grease separator works by the force of gravity. It consists of a precipitation area, a grease collector, a sludge trap and a sampling point. The system reduces the flow rate of the wastewater to allow

solids to sink and settle in the sludge trap. Fats, which have a lower density than water, float to the surface. Once the grease is removed, the wastewater flows to the sewer system. The choice of nominal size for the separator is specified in EN 1825 part 2. The wastewater requirements of the relevant authority must be complied

with (e.g. 14-day emptying; monthly emptying with the approval of the relevant authority).

Tank covers  
 >> on request

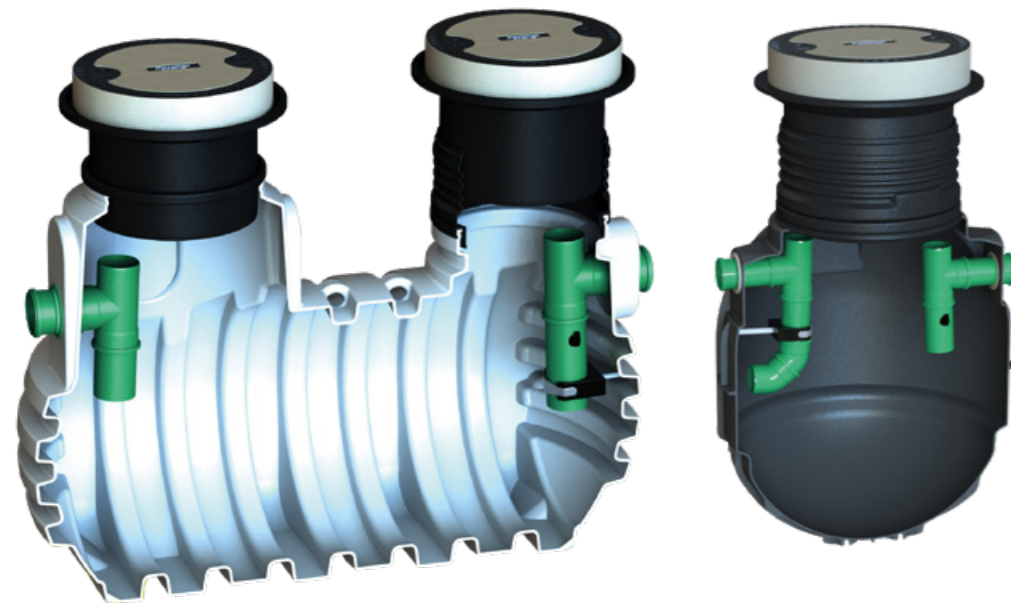

Function of Grease separator

GRAF TV  
[www.graf-water.com/graf-tv](http://www.graf-water.com/graf-tv)



# Grease Separator

Saphir and Diamant



## Dimensions Saphir

NS [l/s]	ø DN [mm]	ø Tank body [mm]	Height [mm]	Weight [kg]
1 (0.26 US gal./s)	100 (4")	1125 (3' 8.2")	1500-1690 (4' 11.1"-5' 6.5")	41 (90 lbs)
2 (0.52 US gal./s)	100 (4")	1125 (3' 8.2")	1500-1690 (4' 11.1"-5' 6.5")	41 (90 lbs)
2 (0.52 US gal./s)	100 (4")	1155 (3' 9.5")	1790-1970 (5' 10.5"-6' 6.6")	70 (154 lbs)
2 (0.52 US gal./s)	100 (4")	1155 (3' 9.5")	1790-1970 (5' 10.5"-6' 6.6")	70 (154 lbs)
2 (0.52 US gal./s)	100 (4")	1155 (3' 9.5")	2110-2290 (6' 11"-7' 6.2")	100 (220 lbs)
4 (1.05 US gal./s)	100 (4")	1155 (3' 9.5")	2110-2290 (6' 11"-7' 6.2")	100 (220 lbs)

## Tank volume [Webcode G5605](#)

Grease [l]	Sludge [l]	Total [l]
200 (52 US gal.)	200 (52 US gal.)	500 (132 US gal.)
200 (52 US gal.)	200 (52 US gal.)	500 (132 US gal.)
300 (79 US gal.)	200 (52 US gal.)	730 (193 US gal.)
200 (52 US gal.)	400 (105 US gal.)	730 (193 US gal.)
300 (79 US gal.)	500 (132 US gal.)	1,025 (271 US gal.)
300 (79 US gal.)	500 (132 US gal.)	1,025 (271 US gal.)

Effectiveness according to EN 1825-1 tested by TÜV Rheinland.



## Dimensions Diamant

NS [l/s]	ø DN [mm]	Length [mm]	Width [mm]	Height [mm]	Weight [kg]
4 (1.05 US gal./s)	150 (6")	2450 (8')	1150 (3' 9")	1845-2115 (6' 0.6"-6' 11.3")	165 (364 lbs)
7 (1.85 US gal./s)	150 (6")	2450 (8')	1150 (3' 9")	1845-2125 (6' 0.6"-6' 11.7")	165 (364 lbs)
10 (2.64 US gal./s)	200 (8")	2450 (8')	1400 (4' 7")	2095-2310 (6' 10.5"-7' 7")	250 (551 lbs)
15 (3.96 US gal./s)	200 (8")	2450 (8')	1400 (4' 7")	2095-2310 (6' 10.5"-7' 7")	250 (551 lbs)

## Tank volume [Webcode G5606](#)

Grease [l]	Sludge [l]	Total [l]
350 (92 US gal.)	700 (185 US gal.)	2,070 (546 US gal.)
350 (92 US gal.)	700 (185 US gal.)	2,070 (546 US gal.)
600 (158 US gal.)	1,500 (396 US gal.)	3,160 (835 US gal.)
600 (158 US gal.)	1,500 (396 US gal.)	3,160 (835 US gal.)

Effectiveness according to EN 1825-1 tested by TÜV Rheinland.



### Separator systems for light fluid liquids class I + II

Separators are needed wherever water is contaminated with oils and other light liquids. Separator systems are classified according to NS (nominal size). When you submit an enquiry for a separator system, we calculate the NS you require based on the EN 858 part 2. Operators of the following facilities must ensure that a suitable, function-

ing separator is installed: Car washes, workshops, fuel stations, vehicle fleets, hazardous goods stores.

### Coalescence separator and fuel separator

The sepa.compact+ separator systems are coalescence separators of class I. They feature an additional coalescence unit that enables a much higher degree of separation. The sepa.compact

separator systems are fuel separators of class II. A fuel separator achieves a degree of separation of less than 100 mg residual oil per litre of water. With a coalescence unit, this can be reduced to less than 5 mg/l.

Tank covers  
» on request



» Optional: different warning systems available

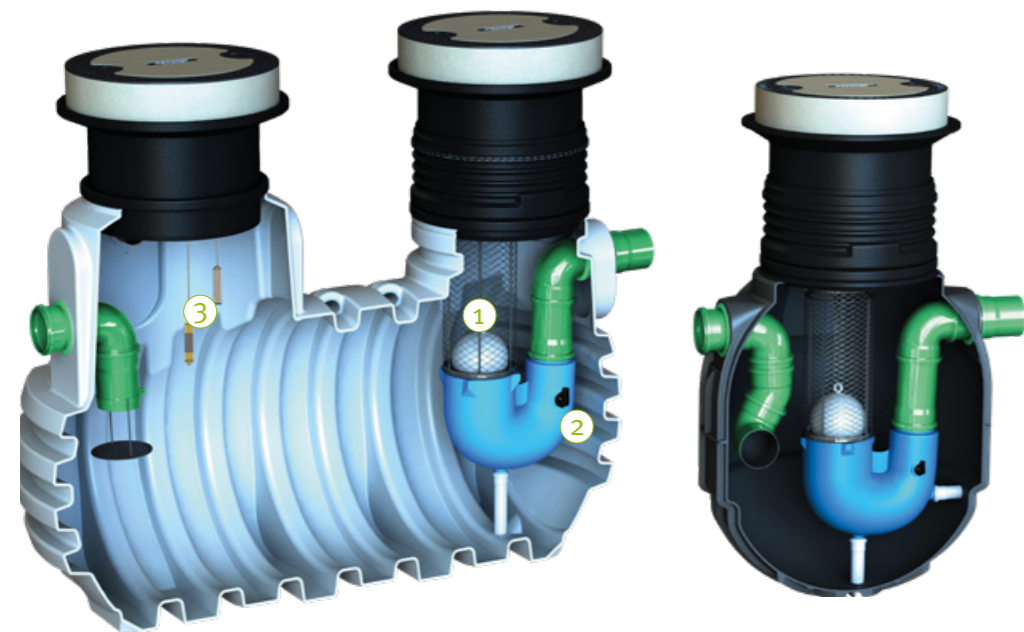

- ① Coalescence unit included with sepa.compact+ system
- ② Integrated sampling connecting point
- ③ Warning sensors



Function of Light fluid separator

GRAF TV  
[www.graf-water.com/graf-tv](http://www.graf-water.com/graf-tv)



# Light Fluid Separator

Saphir and Diamant



### Dimensions Saphir

NS [l/s]	DN [mm]	Length [mm]	Width [mm]	Height [mm]	Weight [kg]
3 (0.79 US gal./s)	150 (6")	1155 (3' 9.5")	1155 (3' 9.5")	1790-1990 (5' 11"-6' 6.4")	80 (176 lbs)
3 (0.79 US gal./s)	150 (6")	1155 (3' 9.5")	1155 (3' 9.5")	2110-2310 (6' 11"-7' 7")	110 (243 lbs)
3 (0.79 US gal./s)	150 (6")	1155 (3' 9.5")	1155 (3' 9.5")	2110-2310 (6' 11"-7' 7")	110 (243 lbs)
6 (1.60 US gal./s)	150 (6")	1155 (3' 9.5")	1155 (3' 9.5")	2110-2310 (6' 11"-7' 7")	110 (243 lbs)

Effectiveness according to EN 858 tested by TÜV Rheinland.

### Tank volume [Webcode G5607](#)

Oil [l]	Sludge [l]	Total [l]
300 (79 US gal.)	600 (158 US gal.)	770 (203 US gal.)
500 (132 US gal.)	800 (211 US gal.)	1,100 (290 US gal.)
300 (79 US gal.)	1,200 (317 US gal.)	1,080 (288 US gal.)
300 (79 US gal.)	1,200 (317 US gal.)	1,080 (288 US gal.)

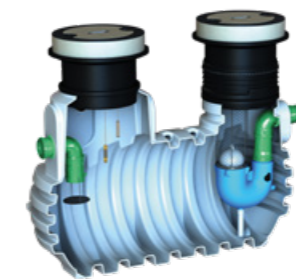

### Dimensions Diamant

NS [l/s]	DN [mm]	Length [mm]	Width [mm]	Height [mm]	Weight [kg]
6 (1.60 US gal./s)	150 (6")	2450 (8')	1150 (3' 9")	1765-2055 (5' 9.5"-6' 9")	165 (364 lbs)
10 (2.64 US gal./s)	150 (6")	2450 (8')	1150 (3' 9")	1765-2055 (5' 9.5"-6' 9")	165 (364 lbs)
10 (2.64 US gal./s)	200 (8")	2450 (8')	1400 (4' 7")	2020-2310 (6' 7.5"-7' 7")	250 (551 lbs)
15 (3.96 US gal./s)	200 (8")	2450 (8')	1400 (4' 7")	2020-2310 (6' 7.5"-7' 7")	250 (551 lbs)

Effectiveness according to EN 858 tested by TÜV Rheinland.

### Tank volume [Webcode G5608](#)

Oil [l]	Sludge [l]	Total [l]
500 (132 US gal.)	2,600 (686 US gal.)	2,210 (584 US gal.)
500 (132 US gal.)	2,600 (686 US gal.)	2,210 (584 US gal.)
660 (174 US gal.)	4,000 (1,056 US gal.)	3,330 (880 US gal.)
660 (174 US gal.)	4,000 (1,056 US gal.)	3,330 (880 US gal.)

### Operation of a coalescence unit

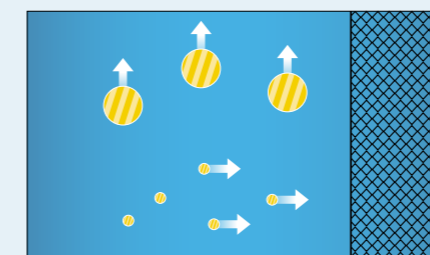

In addition to easily separable drops of oil, a light fluid separator can also contain very fine oil droplets whose density is not sufficiently different from water for them to rise to the surface in the available time. These droplets therefore remain in the outflowing water.

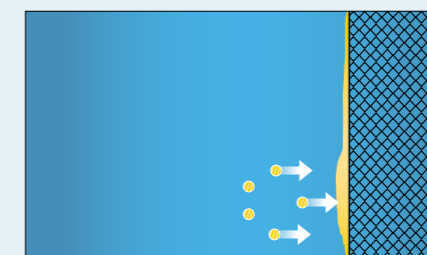

To separate out these smaller droplets, a coalescence material is fitted before the discharge to which the droplets stick and form an oil film.

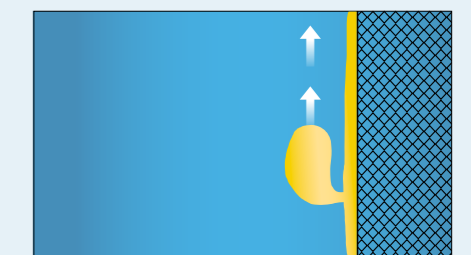

As more oil flows in, the film becomes thicker until it can no longer adhere to the material. Individual drops break off the film, which are large enough to rise to the surface through difference in density and be separated out.



## Carat Underground Tank

- › Carat RS underground tank
- › Carat XL underground tank
- › Carat XXL underground tank

Page 74

Page 84

Page 85

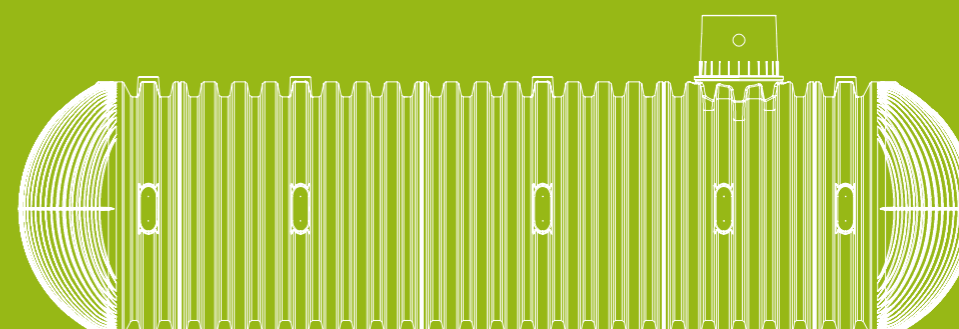

# Carat RS Underground Tank – The GRAF Modular System

Choose your system from four different modulars

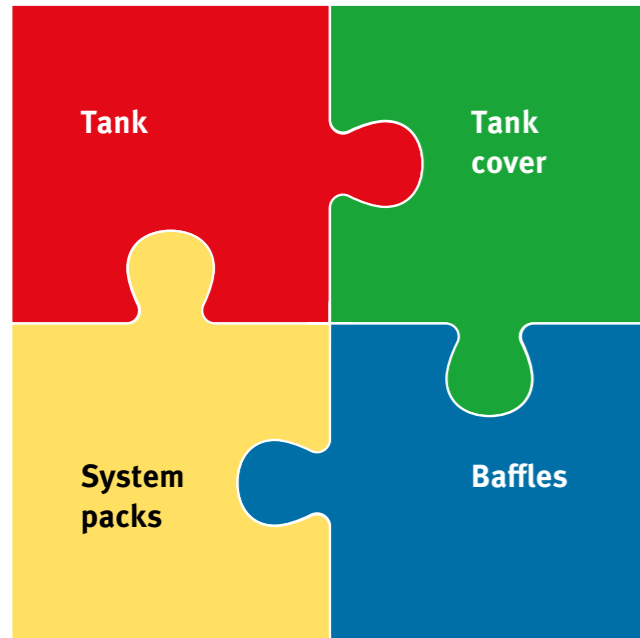

## Tank

Carat RS 2.700 – 6.500 litres



Carat RS 2.700 litres  
Order no. 372028

Carat RS 3.750 litres  
Order no. 372029

Carat RS 4.800 litres  
Order no. 372030

Carat RS 6.500 litres  
Order no. 372031

Tank dome Micro for Carat RS  
Order no. 371009

Tank dome Mini for Carat RS  
Order no. 371041

Tank dome Maxi for Carat RS  
Order no. 371040

## Tank cover

Telescopic dome shaft Mini  
Order no. 371010

Telescopic dome shaft Maxi  
Order no. 371011

Telescopic dome shaft cast iron  
Order no. 371020

Telescopic dome shaft concrete cast-iron  
Order no. 371021

Extension  
Order no. 371003

## Baffles

Baffles – Carat RS 2.700 – 6.500 litres

Baffle 2.700 litres position 1/2:  
Order no. 375067

Baffle 2.700 litres position 1/3:  
Order no. 375077

Baffle 3.750 litres position 1/2:  
Order no. 375025

Baffle 3.750 litres position 1/3:  
Order no. 375080

Baffle 4.800 litres several positions:  
Order no. 375026

Baffle 6.500 litres several positions:  
Order no. 375027

## System packs

one2clean

one2clean plus

Klaro E Professional (Klaro L)

Anaerobix

### Tank (page 76 – 79)

The Carat RS underground tank is the basis for the modular system. It is available in sizes from 2,700 to 6,500 litres and in combined sizes of up to 13,000 litres. Its high quality makes it suitable for vehicle loading and installation in groundwater.

### Tank cover (page 80 – 81)

Would you like to install your tank in the garden or in a driveway? GRAF offers you wide range of telescopic tank covers from plastic to cast iron.

### Baffles (page 82)

The baffle separates the Carat RS underground tank into two or three chambers as desired. This means that wastewater treatment systems with multiple chambers can be accommodated in just one tank. A Carat RS underground tank with baffle is ready for use as a multi-chamber tank.

### System packs (page 83)

There are different types of system packs available. The system pack consists of a control unit (internal or external cabinet) and a set-up kit, which is assembled inside the Carat RS tank.



## Benefits

- ✓ Made of 100 % recycling material
- ✓ Investment security thanks to 15-year warranty – compare it!
- ✓ Very high stability thanks to modern production methods
- ✓ Unique fit accuracy of the components
- ✓ Suitable for vehicle loading (when combined with the cast iron telescopic tank dome)
- ✓ Groundwater-stable thanks to its extremely stable construction
- ✓ Can be expanded as required

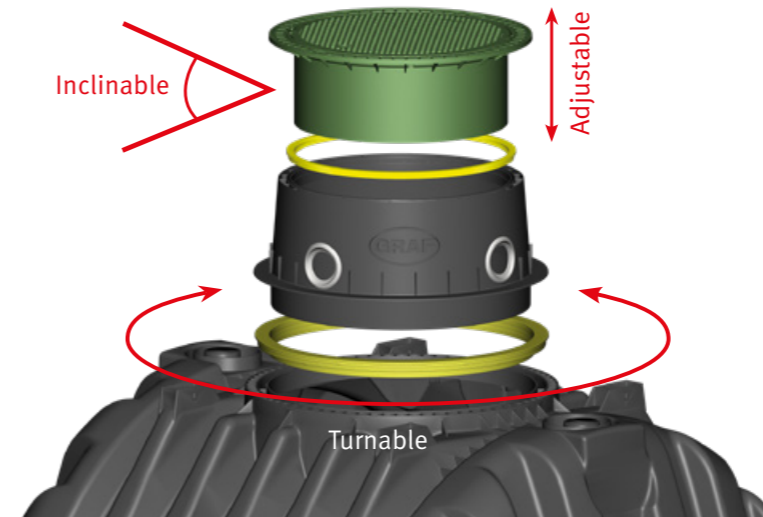
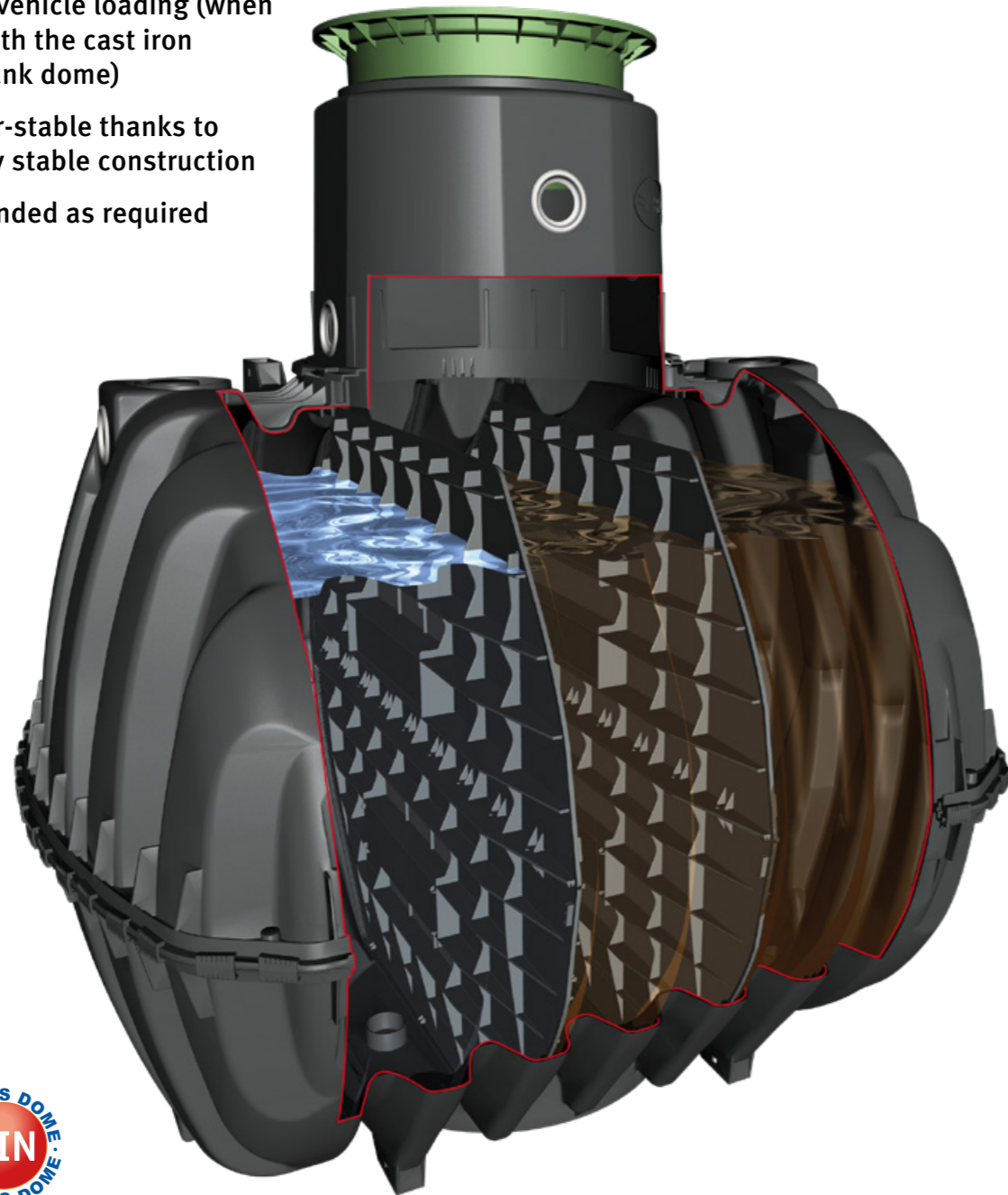

Telescopic dome shaft cast-iron suitable for vehicles

## Flush with ground level

- ✓ Numerous seals to effectively stop dirt getting into the tank
- ✓ Seals are fitted in the intersection between the tank and tank dome and between the tank dome and telescopic tank dome
- ✓ The height of the telescopic tank dome can be smoothly adjusted
- ✓ The telescopic tank dome can additionally be inclined by 5° to suit the local conditions
- ✓ The production tolerances
- ✓ Are kept to a minimum, resulting in unrivalled fitting accuracy

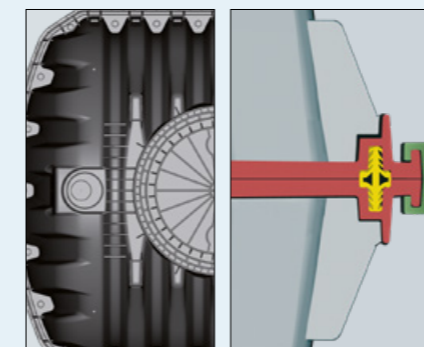

## Extremely stable thanks to the numerous ribs

- ✓ Ribbed tank base
- ✓ Unlike other underground tanks, the wall thickness can be precisely defined and is equal in all areas of the tank
- ✓ Impact-resistant
- ✓ Encircling stabilisation ring in unique H
- ✓ Unique profile for more stability and security



## Easy and safe assembly

- ✓ Quick connection (shown in green) allows the Carat RS tank to be assembled without screws in only a few minutes
- ✓ The top-quality EPDM material used in the profile seals (shown in yellow) has been laboratory-tested
- ✓ The centring bolt (shown in orange) ensures the accurate and easy assembly of the two half-shells, preventing any leaks



# Carat RS Underground Tank – Benefits

Logistical Advantages



## Benefits

- Easy to transport
- Tank consisting of two half-shells
- 5–9 tanks per pallet
- This allows up to 8 times more tank volume to be shipped thanks to the unique product design
- Up to 36 complete wastewater systems or 45 wastewater tanks per lorry



Carat RS: Reduce freight costs by up to 80%

GRAF TV  
www.graf-water.com/graf-tv

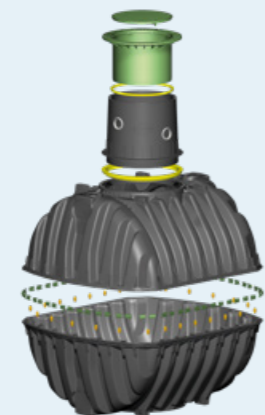

# Carat RS Underground Tank

Choose your tank size



## Carat RS underground tank Suitable for vehicle loading

Size 2,700 – 6,500 litres. Designed to be used in conjunction with the vehicle loading telescopic tank dome. The access dome is designed in accordance with DIN testing.



Tank dome Maxi  
Order no. 371040



Tank dome Mini  
Order no. 371041



Tank dome Micro  
Order no. 371009



Illustration shows 4,800 litre tank with telescopic dome shaft for pedestrian loading

Webcode G5305

## Dimensions

Volume [l]	Width B [mm]	Length L [mm]	Height H [mm]	Height H <sub>tot</sub> [mm]	Height of tank dome ht [mm]	Inner Ø of tank dome [mm]	Weight [kg]	Order no.
2,700 (700 US gal.)	1565 (61.6")	2080 (81.9")	1400 (55.1")	2010 (79.1")	610 (24.0")	650–800 (25.6–31.5")	120 (265 lbs)	372028
3,750 (1,000 US gal.)	1755 (69.1")	2280 (89.8")	1590 (62.6")	2200 (86.6")	610 (24.0")	650–800 (25.6–31.5")	150 (331 lbs)	372029
4,800 (1,250 US gal.)	1985 (78.2")	2280 (89.8")	1820 (71.6")	2430 (95.7")	610 (24.0")	650–800 (25.6–31.5")	185 (408 lbs)	372030
6,500 (1,700 US gal.)	2190 (86.2")	2390 (94.1")	2100 (82.7")	2710 (106.7")	610 (24.0")	650–800 (25.6–31.5")	220 (485 lbs)	372031

## Technical data

Max. earth covering (without groundwater vehicle loading)	1200 mm (47.2")
Max. vehicle weight	12 to (26456 lbs)
Earth covering required for vehicle loading	800–1200 mm (31.5–47.2")
Groundwater stability	Up to 350 mm (13.8")
Earth covering required for groundwater stability	800–1200 mm (31.5–47.2")
Connection	DN 100 / DN 150 / DN 200 on top

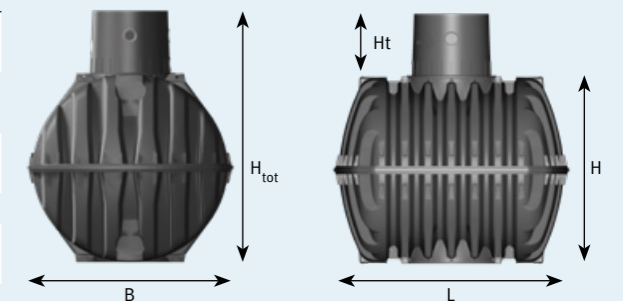





# Carat RS Underground Tank

Choose your tank domes and covers



**Tank dome Micro**

- Weight: 7 kg
- including green lid
- for shallow excavation
- earth cover only 90 mm

Order no. 371009

**Tank dome Maxi**

- Weight: 15 kg
- For large earth coverings (loading capacity)
- incl. 5 edge seals

Order no. 371040

**Tank dome Mini**

- Weight: 11 kg
- For especially flat installation
- incl. 3 edge seals

Order no. 371041

**Extension for shafts and domes**

- Weight: 6 kg
- The earth covering can be raised 300 mm using the extension

Order no. 371003

**Telescopic dome shaft Mini**

- with PP cover
- suitable for pedestrian loading
- Weight: 9 kg
- Adjustable earth covering across upper tank surface

plus 140 mm – 340 mm earth covering

Order no. 371010

**Telescopic dome shaft cast iron**

- Suitable for vehicle loading – with childproof cast iron cover up to 3.5 t
- Weight: 55 kg
- Adjustable earth covering across upper tank surface

plus 140 mm – 440 mm earth covering

Order no. 371020

**Telescopic dome shaft Maxi**

- with PP cover
- suitable for pedestrian loading
- Weight: 15 kg
- Adjustable earth covering across upper tank surface

plus 140 mm – 440 mm earth covering

Order no. 371011

**Telescopic dome shaft concrete cast-iron \***

- Suitable for vehicle/ lorry-bearing
- Weight: 11 kg
- Cover to be provided on site
- Adjustable earth covering across upper tank surface
- For commercially available concrete rings/covers (to be provided on site)

plus 140 mm – 440 mm earth covering

Order no. 371021

\*on request

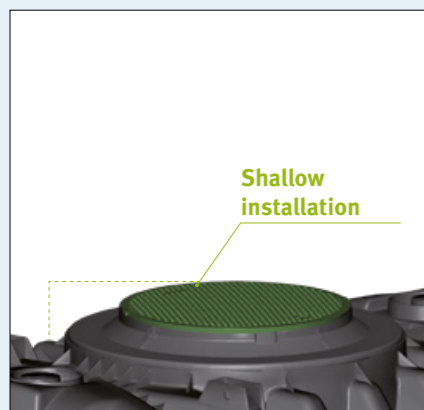

Tank dome Micro

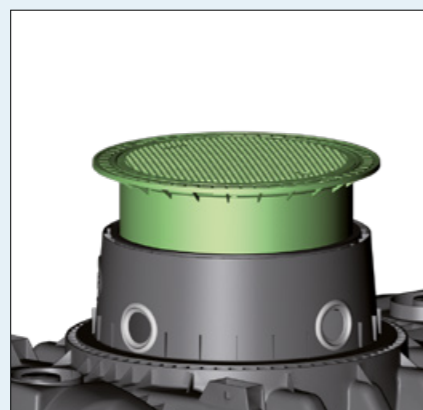

Tank dome Mini



Tank dome Maxi



Telescopic dome shaft Mini suitable for pedestrian loading



Telescopic dome shaft cast-iron suitable for vehicles



# Carat RS Underground Tank

Choose your baffle position

The baffle separates the Carat RS underground tank into two or three chambers as desired. It consists of two halves and is simple to insert when assembling the second tank half of the Carat RS. A profile seal provides reliable and permanent separation of the chambers. The Carat RS underground tank with baffle is ready for use as a multi-chamber tank. This can then be expanded by means of a system pack to create a wastewater treatment system (» page 83). The system pack is simply fitted to the baffle and the control unit is installed in the house – and the wastewater treatment system is ready to go.

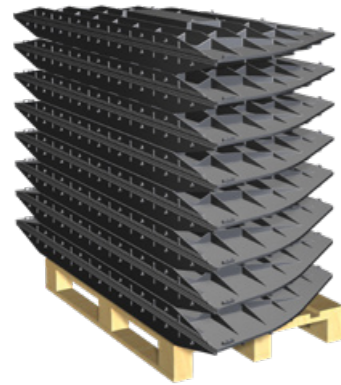
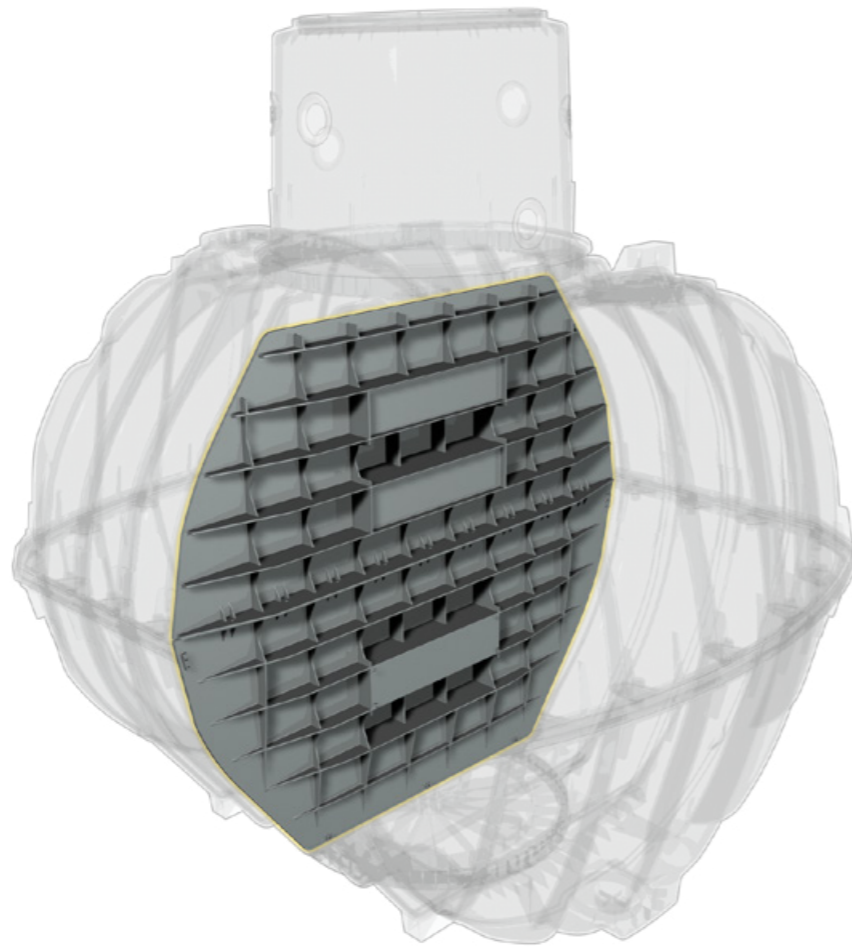

## Baffle for Carat RS tank

Volume [l]	pcs/pal	Positions	Weight [kg]	Order no.
2,700	9	1/2	20	375067
2,700	9	1/3	20	375077
3,750	7	1/2	25	375025
3,750	7	1/3	25	375080
4,800	5	several positions	35	375026
6,500	5	several positions	45	375027



The baffles of the Carat RS underground tank are supplied on pallets and can easily be inserted in the tanks as needed.

## Flexible baffle positions

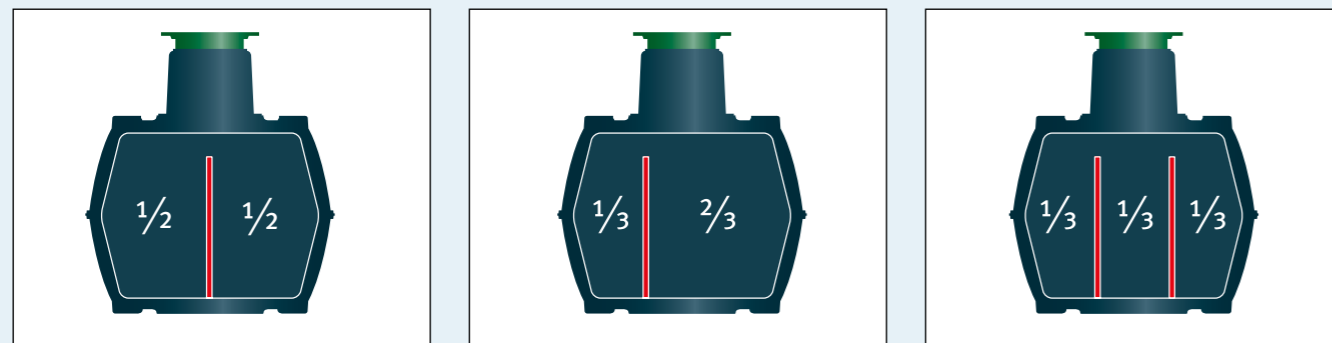

Examples of different baffle positions.



# Carat RS Underground Tank

Choose your system pack



## System pack one2clean / one2clean plus



The system pack one2clean (» page 10) works according to the SBR air lift pump process. This requires a wastewater tank with a Saum baffle. Scope of supply: control cabinet with air compressor for internal mounting, one2clean system pack comprising air lift pumps and tube diffuser. Air hose not included.

### SBR hose package

Includes: 1 x Ø 19 mm and 1 x Ø 13 mm PVC hose; colour-coded

10 m	Order no. 107686
20 m	Order no. 107688

Inhabitants [max.]	Volume [l]	System packs [Order no.]	
		one2clean	one2clean plus
<b>For one-tank systems</b>			
3	2,700	106850	106417
5	3,750	106851	106418
7	4,800	106852	106419
9	6,500	106853	106420
<b>For two-tank systems</b>			
7	2 x 2,700	106854	106425
10	2 x 3,750	106855	106426
14	2 x 4,800	106856	106427
18	2 x 6,500	106857	106428

## System pack Klaro E Professional



The system pack Klaro E Professional (» page 18) works according to the SBR air lift pump process. This requires a wastewater tank with two chambers. Scope of supply: control cabinet with air compressor for internal mounting, Klaro E Professional system pack comprising air lift pumps and disk diffuser. Air hose not included.

### SBR hose package

Includes: 1 x Ø 19 mm; 3 x Ø 13 mm, PVC hose; colour-coded

10 m	Order no. 107190
20 m	Order no. 107192

## Sizes

Inhabitants [max.]	Volume [l]	System packs [Order no.]	
		Set-up kits	Internal control cabinet
<b>For multitank systems</b>			
16	2 x 3,750	107496	107705
22	2 x 4,800	107497	107705
28	2 x 6,500	107498	107705
32	4 x 3,750	107797	107471
44	4 x 4,800	107798	107471
50	4 x 6,500	107799	107472
<b>For Klaro L</b>			
60	4 x 6,500	372710	
90	5 x 6,500	372711	
120	7 x 6,500	372712	
150	9 x 6,500	372713	
180	10 x 6,500	372714	

## Anaerobix



The filter system Anaerobix (» page 58) is an anaerobic filter system (filled with carrier material) for GRAF wastewater tanks. It increases the cleaning performance of a wastewater tank several times over. Scope of supply: GRAF wastewater tank with Anaerobix filter.

## Sizes

Inhabitants [max.]	Volume [l]	Anaerobix 60 l [Order no.]
8 – 9	Carat RS 2,700 l	107600
10 – 12	Carat RS 3,750 l	107600
12 – 16	Carat RS 4,800 l	107600
16 – 21	Carat RS 6,500 l	107600

Further sizes on request

# Carat XL Underground Tank

8,500 and 10,000 litres



## Benefits

- ✓ Suitable for loading up to 12 t
- ✓ Can be mounted in groundwater
- ✓ Lower weight than concrete and steel
- ✓ Various connection surfaces DN 100 / 150 / 200
- ✓ Investment security thanks to a 15-year warranty



Illustration shows 10,000 litre tank with telescopic dome shaft with cast iron lid, suitable for vehicle loading.

Webcode G5303



## Dimensions

Volume [l]	Width B [mm]	Length L [mm]	Height H [mm]	Height H <sub>tot</sub> [mm]	Height of dome shaft ht [mm]	Internal Ø of dome shaft [mm]	Weight [kg]	Order no.
8,500	2040	3500	2085	2695	610	650	380	370005
10,000	2240	3520	2285	2895	610	650	456	370006

## Technical data

Max. earth covering (without groundwater vehicle loading)	2000 mm (6' 6.7")
Max. axle load	3.5 to (7716 lbs) with 2.2 to cast iron cover, 12 to (26456 lbs) with telescopic dome shaft lorry
Max. total weight	12 to (26456 lbs)
Earth covering required for vehicle loading	800 mm – 2000 mm (31.5" – 6' 6.7")
Groundwater stability	up to middle of tank
Earth covering required for groundwater stability	800 mm – 1800 mm (31.5" – 5' 10.9")
Connection	5 x DN 150 (6") + 2 x DN 200 (8") (on top)

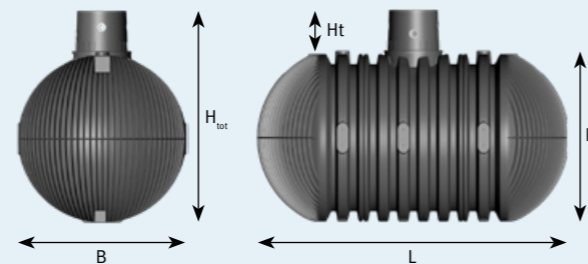

# Carat XXL Underground Tank

up to 122,000 litres



## Benefits

- ✓ Suitable for loading up to 40 t
- ✓ Can be mounted in groundwater
- ✓ Lower weight than concrete and steel
- ✓ Various connection surfaces DN 100 / 150 / 200
- ✓ Available with DN 300 connection as an option
- ✓ Available with a second tank dome as an option
- ✓ Investment security thanks to a 15-year warranty



Illustration shows Carat XXL 46,000 l with telescopic dome shaft suitable for loading.

Webcode G5304



## Dimensions

Volume [l]	Width W [mm]	Length L [mm]	Height H [mm]	Height H <sub>tot</sub> [mm]	Height of dome shaft ht [mm]	Internal Ø of dome shaft [mm]	Weight [kg]	Order no.
16,000	2500	4660	2550	3160	610	650	805	380001
22,000*	2500	6145	2550	3160	610	650	1015	380000
26,000	2500	7045	2550	3160	610	650	1150	380002
32,000*	2500	8530	2550	3160	610	650	1360	380003
36,000	2500	9430	2550	3160	610	650	1495	380004
42,000*	2500	10915	2550	3160	610	650	1705	380005
46,000	2500	11815	2550	3160	610	650	1840	380006
52,000*	2500	13300	2550	3160	610	650	2050	380007
56,000	2500	14200	2550	3160	610	650	2185	380008
62,000*	2500	15685	2550	3160	610	650	2395	380009
66,000	2500	16585	2550	3160	610	650	2530	380010
72,000*	2500	18070	2550	3160	610	650	2740	380011
76,000	2500	18970	2550	3160	610	650	2875	380012

Up to 122,000 litres on request

\*with a second tank dome

## Technical data

Max. earth covering:	1500 mm (4' 11")
Max. axle load:	8 to (17637 lbs)
Max. vehicle weight:	3.5 to (7716 lbs) with 2.2 to cast iron cover, 40 to (88183 lbs) with telescopic dome shaft lorry
Earth covering required for vehicle loading	800 – 1500 mm (31.5" – 4' 11") vehicle loading 1000 – 1500 mm (3' 3.4" – 4' 11") lorry-bearing
Groundwater stability:	up to the middle of the tank
Earth covering required for groundwater stability:	800 – 1500 mm (31.5" – 4' 11")
Connection:	5 x DN 150 (6") (or 10 x 5 x DN 150 (6")) + DN 200 (8") on top; Optionally up to DN 300 (12")

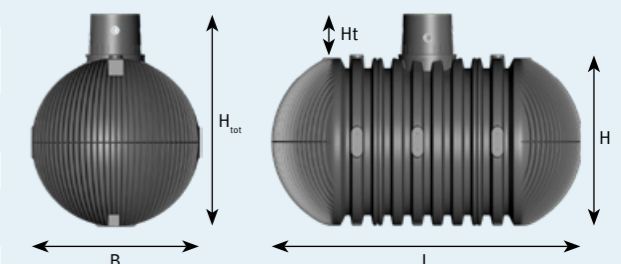



# Infiltration

> Infiltration Tunnel

Page 88

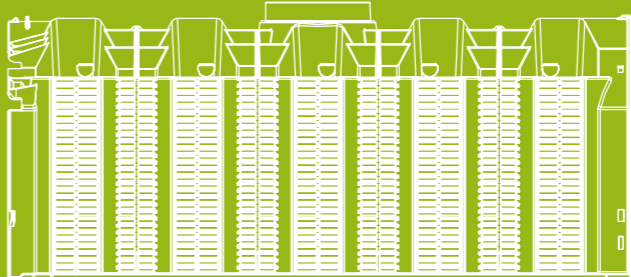



The Graf Infiltration Tunnel has been mainly designed for the use in private and rural areas. The system, which consists of one or more tunnel modules and two end plates, can be extended as desired. The tunnel is laid in one or more lines of the same level. As the weight of one module is only 11 kg, the handling of the Infiltration Tunnel is excellent. The surface above the tunnels is suitable for vehicle loading, offering varied possibilities for use.

### Up to 12,000 litres infiltration volume per pallet

Thanks to its special design, the GRAF Infiltration Tunnel can be stacked easily. Consequently, the shipment of up to 40 Infiltration Tunnels on one pallet saves considerable transport and storage costs.

### Vehicle loading

For versatility, the surface above the infiltration tunnels can withstand a continuous load of up to 100 kN/m<sup>2</sup> and is therefore also suitable for vehicle loading.

### Easy installation

The GRAF Infiltration Tunnels are laid in lines and can be flexibly adapted to specific conditions and to the individual storage volume requested. The installation of the modules is easy, quick and variable. Installation is possible without heavy equipment, as one Infiltration Tunnel weighs just 11 kg. The tunnel modules are simply joined together in a line and two end plates are fitted per line.

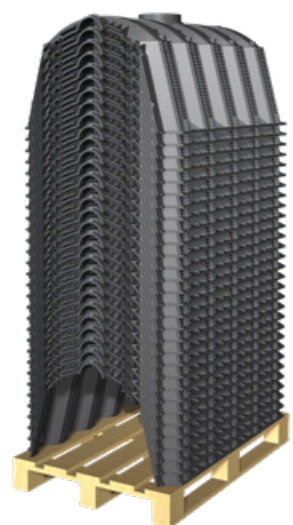

Flexible connection options  
DN 100/200 (4"/8")

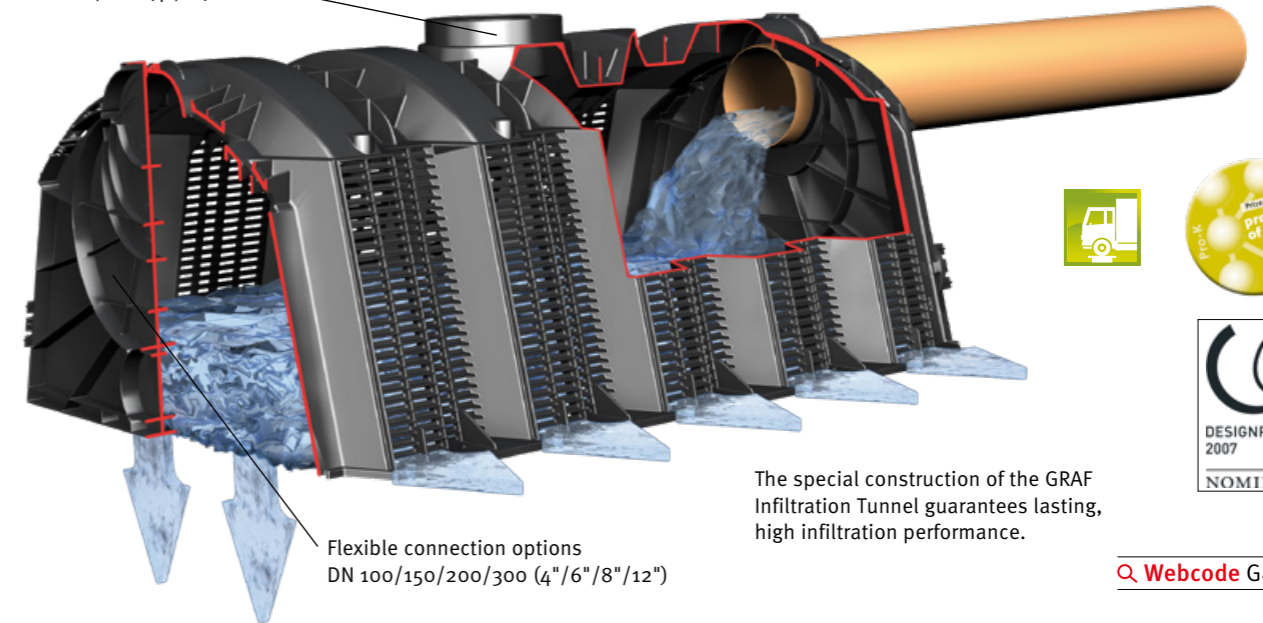

Q Webcode G4103



### Infiltration Tunnel lorry

Volume	Length	Width	Height	Weight	Colour	Order no.
300 l (79 US gal.)	1160 mm (45.7")	800 mm (31.5")	510 mm (20")	11 kg (24.4 lbs)	black	230010

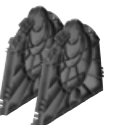

### End plate for Infiltration Tunnel / Twin

Item	Length [mm]	Colour	Order no.
End plates (Set of 2 units)	30 (1.2")	black	231004

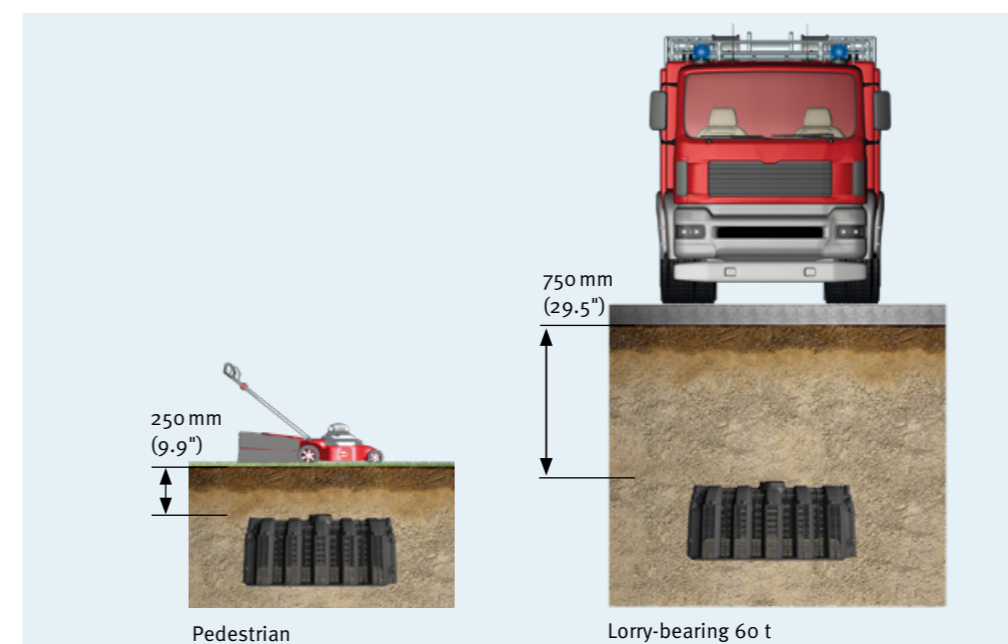

**Inspection end**  
DN 200 (8")  
Order no. 340527



**Deaeration end**  
DN 100 (4")  
Order no. 369017



**GRAF-Tex geotextile**  
For an Infiltration Tunnel size of 2.50 x 2.50 m (8' 2.4" x 8' 2.4")  
Order no. 231006



**Roll width 5 m (16' 4.8")**  
Order no. 231002

# Internationally proven: GRAF Wastewater Treatment Systems



10 inhabitants, Julita (Sweden)



130 inhabitants, Saalburg (Germany)



90 inhabitants, Tehran (Iran)



6 inhabitants, Landsveit (Iceland)



4 inhabitants, Döbeln (Germany)



50 inhabitants, Šuškova (Latvia)



150 inhabitants, Annas Skärgård (Sweden)



7 inhabitants, Tiflis (Georgia)



115 inhabitants, Le Pasquier (France)



5 inhabitants, Uurainen (Finland)



200 inhabitants, Tumenzogt (Mongolia)



46 inhabitants, Cuenca (Spain)



15 inhabitants, Fürenalp (Switzerland)



60 inhabitants, Sofia (Bulgaria)



35 inhabitants, Le Mans (France)



140 inhabitants, Mexico City (Mexico)



32 inhabitants, British Columbia (Canada)



200 inhabitants, Rudenki Town (Ukraine)

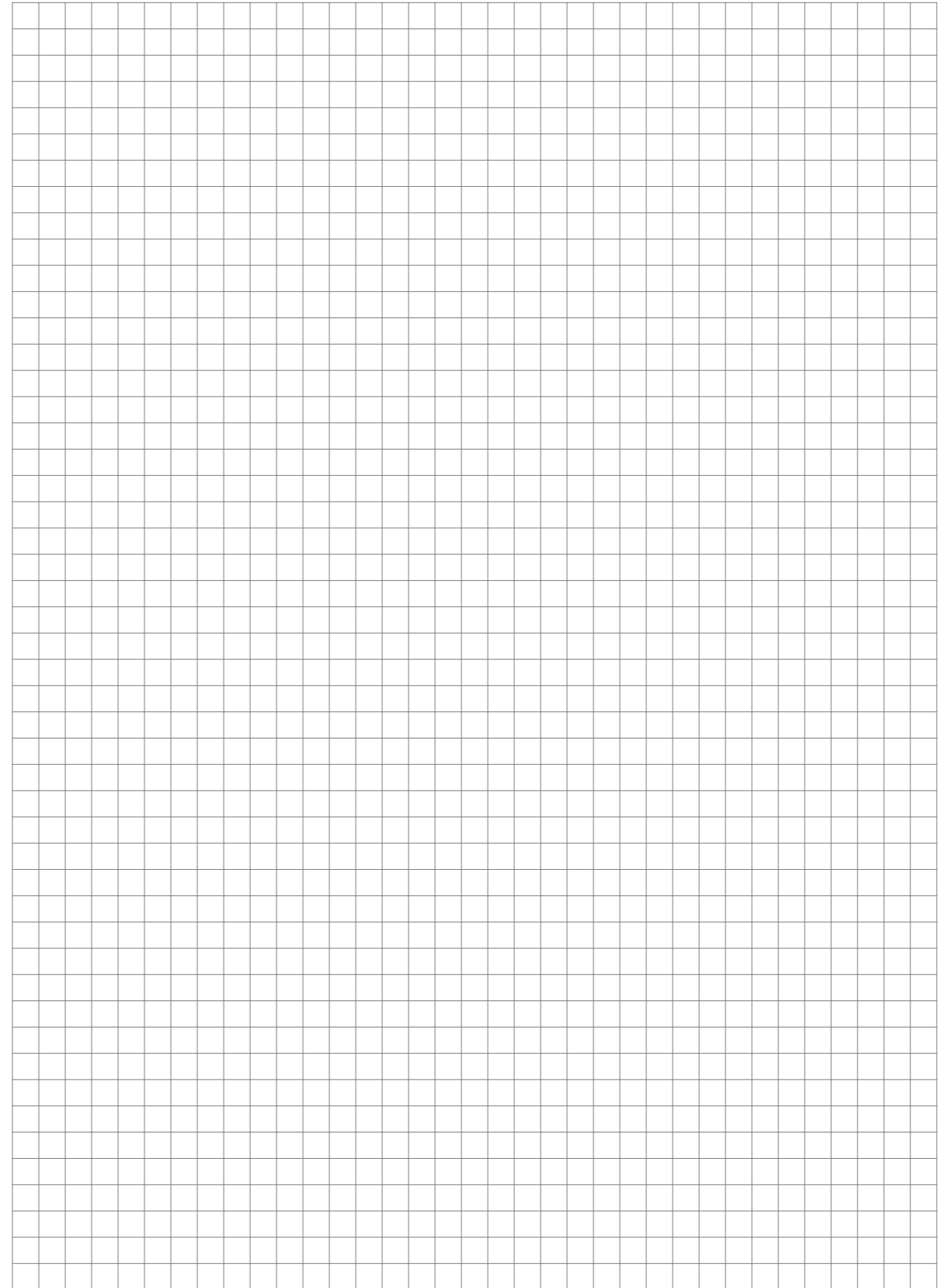
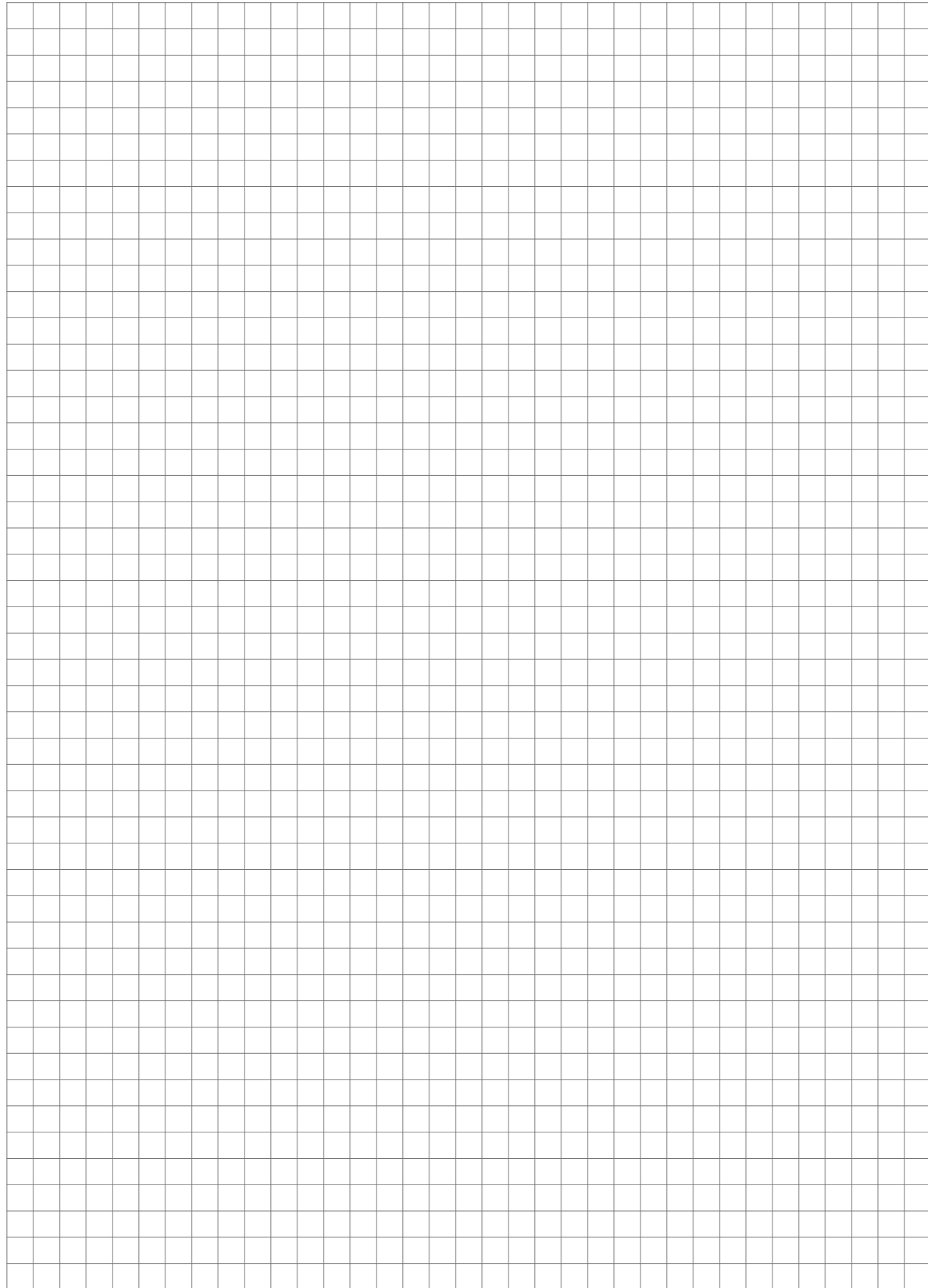

# Stormwater Management

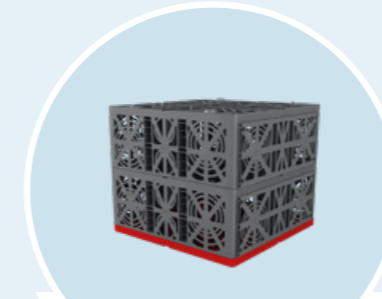

**GRAF EcoBloc  
Inspect flex**



**GRAF EcoBloc  
maxx**



**Vario 800 flex  
shaft system**



**Multi Infiltration shaft  
DN 400 / 600**

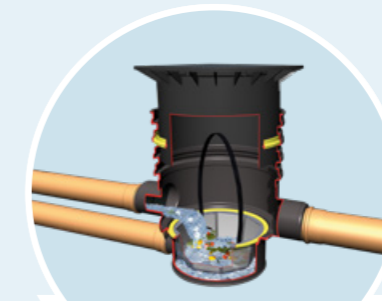

**Industrial Universal  
filter 3**



**Carat RS retention  
detention**



**Infiltration  
Tunnel**



**Infiltration  
Tunnel twin**



[www.graf.info](http://www.graf.info)

**Stormwater Management**  
For more information about our  
stormwater management,  
ask for our catalogue.





[www.graf.info](http://www.graf.info)

RAINWATER HARVESTING



STORMWATER MANAGEMENT



WASTEWATER TREATMENT SOLUTIONS



SEPARATORS



GARDEN PRODUCTS & MULTI-PURPOSE CONTAINERS



### Rainwater Harvesting Solutions

For more information about our Rainwater Harvesting Solutions, ask for our catalogue.

#### Prices:

A price list with our export conditions is available on request.

#### Warranty clause:

The warranty mentioned in this brochure only refers to the tank in question and not to the accessories. Within the warranty period we grant free replacement of the material. Further benefits are excluded. Pre-condition for warranty benefits are proper handling, assembly and installation according to the mounting guidelines.

Over and above the statutory regulation, GRAF is lengthening the warranty period for a number of underground tanks. This relates to proper handling, assembly and installation in accordance with the installation manual, as well as leakproofness, usability and static safety. The prerequisites of this are competent assembly and operation in accordance with the requirements, namely the currently valid installation and operating instructions and the prevailing standards.

N.B. Protect tanks from frost when installed aboveground! In case of groundwater installation, please contact us for further information previous to the purchase!

For all indications of measurements in this brochure we reserve a tolerance of +/- 3%. The useful volume of the tanks may be up to 10% lower than the tank capacity, according to the connecting option.

Technical modifications and further development of the different products are subject to change. Errors excepted.

For all our offers and conclusions of contract are only valid our General Terms and Conditions of Business dated 01/10/2012 which we will send to you on request.

Photo copyright: Fotolia.com: © Alexandr\_Ozerov (page 3), © ps\_42 (page 4+25), © Nikolai\_Sorokin (page 6), © Lucky\_Dragon (page 11+17), © Lyd\_Photo (page 32), © Calado (page 48), © pure-life-pictures (page 52), © Milnes\_Studio (page 68), © Wendell\_Franks\_2008 (page 70)

Otto Graf GmbH  
Kunststoffzeugnisse  
Carl-Zeiss-Straße 2 – 6  
DE-79331 Teningen

Tel.: +49 7641 589-0  
Fax: +49 7641 589-50  
mail@graf.info

GRAF UK Ltd  
Regen House  
Beaumont Road  
Banbury, Oxfordshire  
UK-OX16 1RH

Phone: +44 1608 661-500  
Fax: +44 01295 211333  
info@grafuk.co.uk

© Otto Graf GmbH/Item no. 960143/EN

